

CH 系列 IC 常用封装尺寸

版本: 3H

<https://wch.cn>

封装形式	页码
目录	1
DIP 类 (PDIP)	4
DIP8	4
DIP14	5
DIP16	6
DIP18	7
DIP20	8
DIP24S (SKDIP24、DIP24-300mil)	9
DIP28S (SKDIP28、DIP28-300mil)	10
DIP28 (DIP28W、DIP28-600mil)	11
SDIP28 (SDIP28-400mil)	12
SDIP32 (SDIP32-400mil)	13
SOP 类 (SOIC)	14
SOP8、eSOP8	14
SOP14	15
SOP16 (SOP16-150mil)	16
SOP18	17
SOP20	18
SOP24	19
SOP28	20
SOP30	21
SSOP 类	22
SSOP10 (SSOP10-150mil-1.00)、eSSOP10	22
SSOP16 (SSOP16-209mil-0.65)	23
SSOP20 (SSOP20-209mil-0.65)	24
SSOP24 (SSOP24-209mil-0.65)	25
SSOP28 (SSOP28-209mil-0.65)	26
MSOP 类	27
MSOP10	27
TSSOP 类 (4.4mm, 173mil)	28
TSSOP8	28
TSSOP24	32
TSSOP28	33
QSOP 类 (3.9mm, 150mil)	34
QSOP16 (SSOP16-150mil-0.635)	34
QSOP20 (SSOP20-150mil-0.635)	35
QSOP24 (SSOP24-150mil-0.635)	36
QSOP28 (SSOP28-150mil-0.635)	37
QFP 类 (PQFP、LQFP、TQFP)	38
PQFP44 (QFP44)	38
PQFP52 (QFP52)	39
PQFP64 (QFP64)、LQFP64-14*14	40
PQFP80 (QFP80)	41
LQFP32 (LQFP32-7*7)	42

LQFP44 (LQFP44-10*10)	4 3
LQFP64M (LQFP64-10*10)	4 6
LQFP80 (LQFP80-12*12)	4 7
LQFP100 (LQFP100-14*14)	4 8
LQFP128 (LQFP128-14*14)	4 9
LQFP144 (LQFP144-20*20)	5 0
QFN 类	5 1
QFN/DFN 命名规则参考	5 1
QFN10L14X18 (QFN10-1.4*1.8*0.55-0.4)	5 2
QFN10L15X2 (QFN10-1.5*2*0.55-0.4)	5 3
QFN12 (QFN12-2*2*0.5-0.4)	5 4
QFN14X25 (QFN14-2.5*2.5*0.75-0.5)	5 5
QFN16C2 (QFN16C-2*2*0.55-0.4)	5 6
QFN16 (QFN16-3*3)	5 7
QFN16X4 (QFN16-4*4)	5 8
QFN20 (QFN20-3*3)	5 9
QFN20X4 (QFN20-4*4)	6 0
QFN20X25X45 (QFN20-2.5*4.5*0.75-0.5)	6 1
QFN20C2 (QFN20C-2*2*0.55-0.32)	6 2
QFN24 (QFN24-4*4)	6 3
QFN24X3 (QFN24-3*3*0.55-0.4)	6 4
QFN26C3 (QFN26C-3*3*0.75-0.4)	6 5
QFN28 (QFN28-4*4)	6 6
QFN28X5 (QFN28-5*5)	6 7
QFN32 (QFN32-4*4)	6 8
QFN32X5 (QFN32-5*5)	6 9
QFN32C28X45 (QFN32C-2.8*4.5*0.75-0.4)	7 0
QFN36C4 (QFN36C-4*4*0.75-0.4)	7 1
QFN36X6 (QFN36-6*6)	7 2
QFN40 (QFN40-5*5)	7 3
QFN40X6 (QFN40-6*6)	7 4
QFN42X35X9 (QFN42-3.5*9*0.75-0.5)	7 5
QFN42C35X9 (QFN42C-3.5*9*0.75-0.5)	7 6
QFN46C5 (QFN46C-5*5*0.75-0.4)	7 7
QFN48 (QFN48-5*5*0.75-0.35)	7 8
QFN48X6 (QFN48-6*6)	7 9
QFN48X7 (QFN48-7*7)	8 0
QFN56 (QFN56-7*7)	8 1
QFN56X8 (QFN56-8*8)	8 2
QFN64 (QFN64-8*8)	8 3
QFN64X9 (QFN64-9*9)	8 4
QFN68 (QFN68-8*8)	8 5
QFN76 (QFN76-9*9)	8 6
QFN80 (QFN80-9*9)	8 7
QFN88 (QFN88-10*10)	8 8
DFN 类	8 9
DFN6L12 (DFN6-1.2*1.2*0.4-0.4)	8 9
DFN6 (DFN6-2*2)	9 0
DFN8 (DFN8-2*2)	9 1
DFN10 (DFN10-2*2)	9 2

DFN10X3 (DFN10-3*3)	9 3
SOT 类.....	9 4
SOT23-3	9 4
SOT23-5、TSOT23-5L	9 5
SOT23-6、TSOT23-6L	9 6
SOT23-8、TSOT23-8L	9 7
SOT363 (SC70-6L)	9 8
SOT353 (SC70-5L)	9 9

说明：所有尺寸标注的单位都是 mm（毫米），
引脚节距（中心间距）总是标称值，没有误差；
除此之外的尺寸误差不大于±0.2mm 或者±10%两者中的较大值。

DIP 类 (PDIP)

DIP8

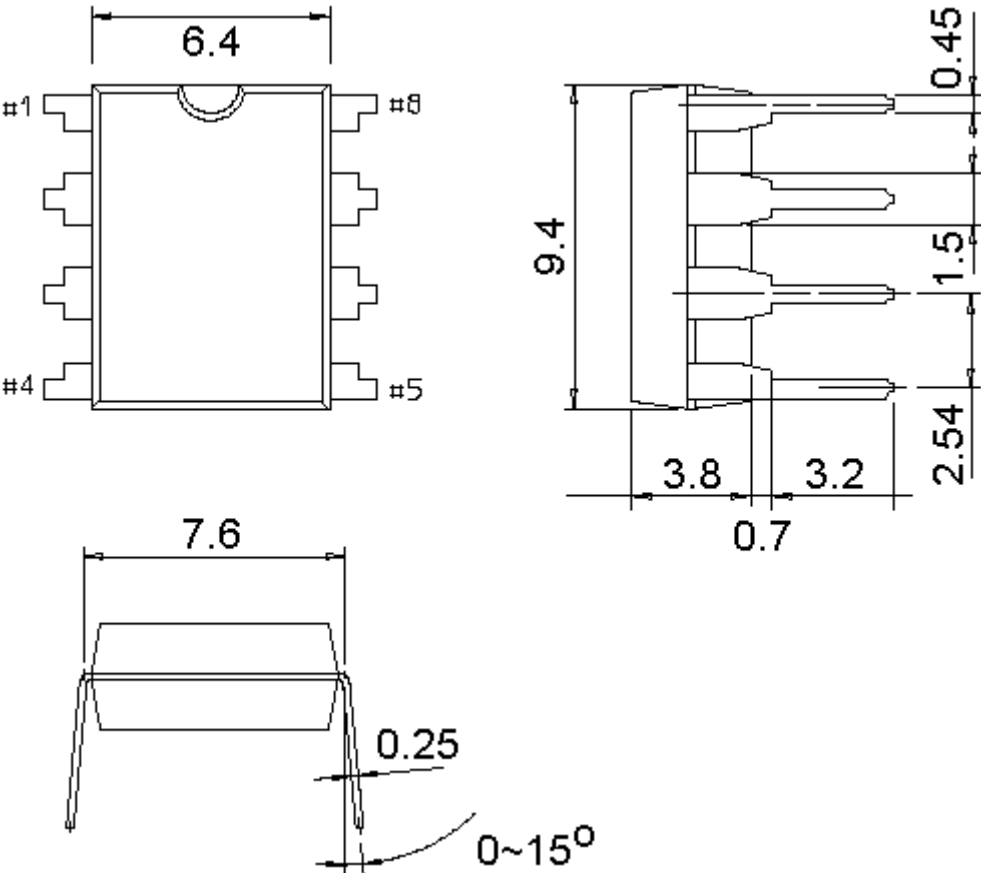

DIP14

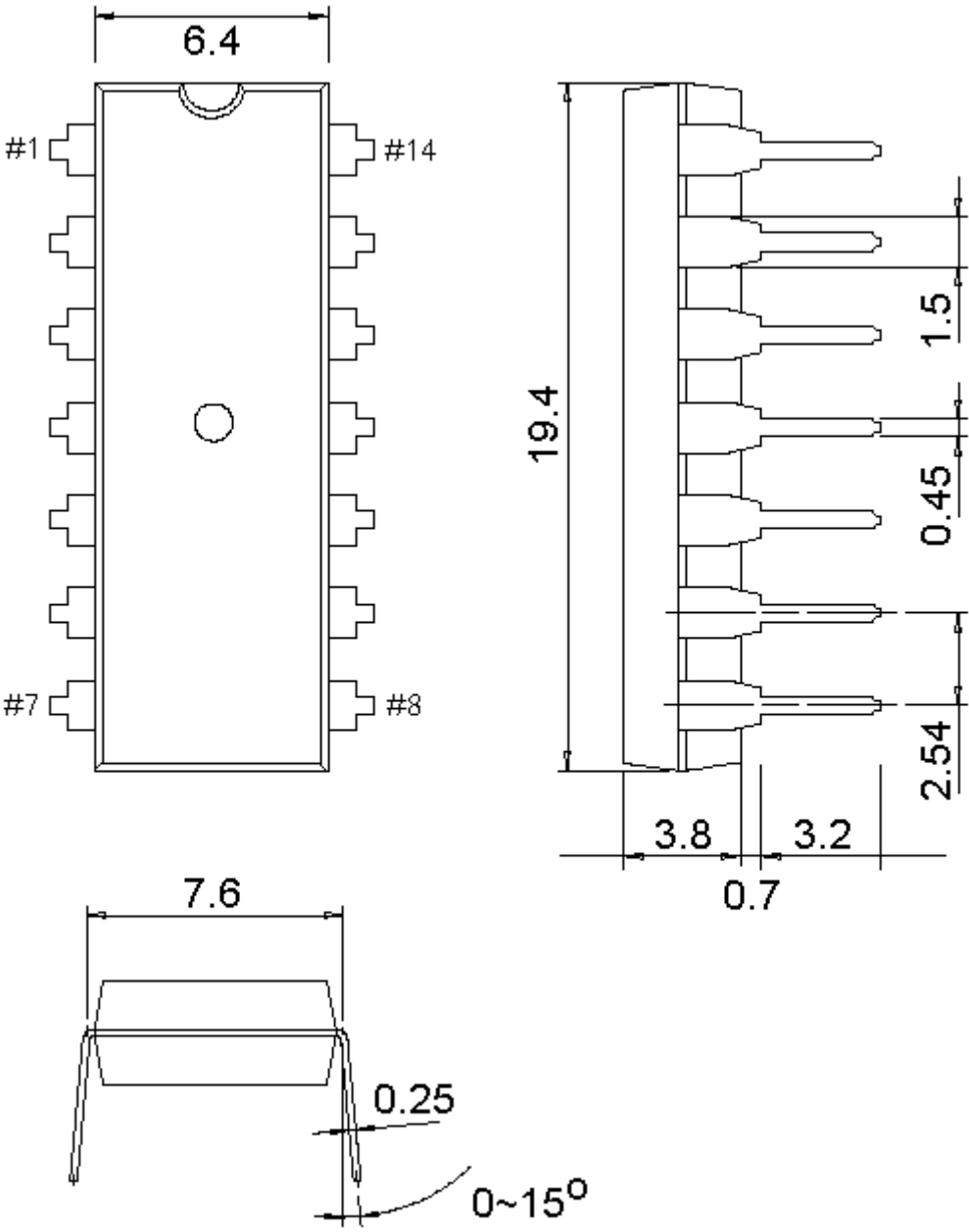

DIP16

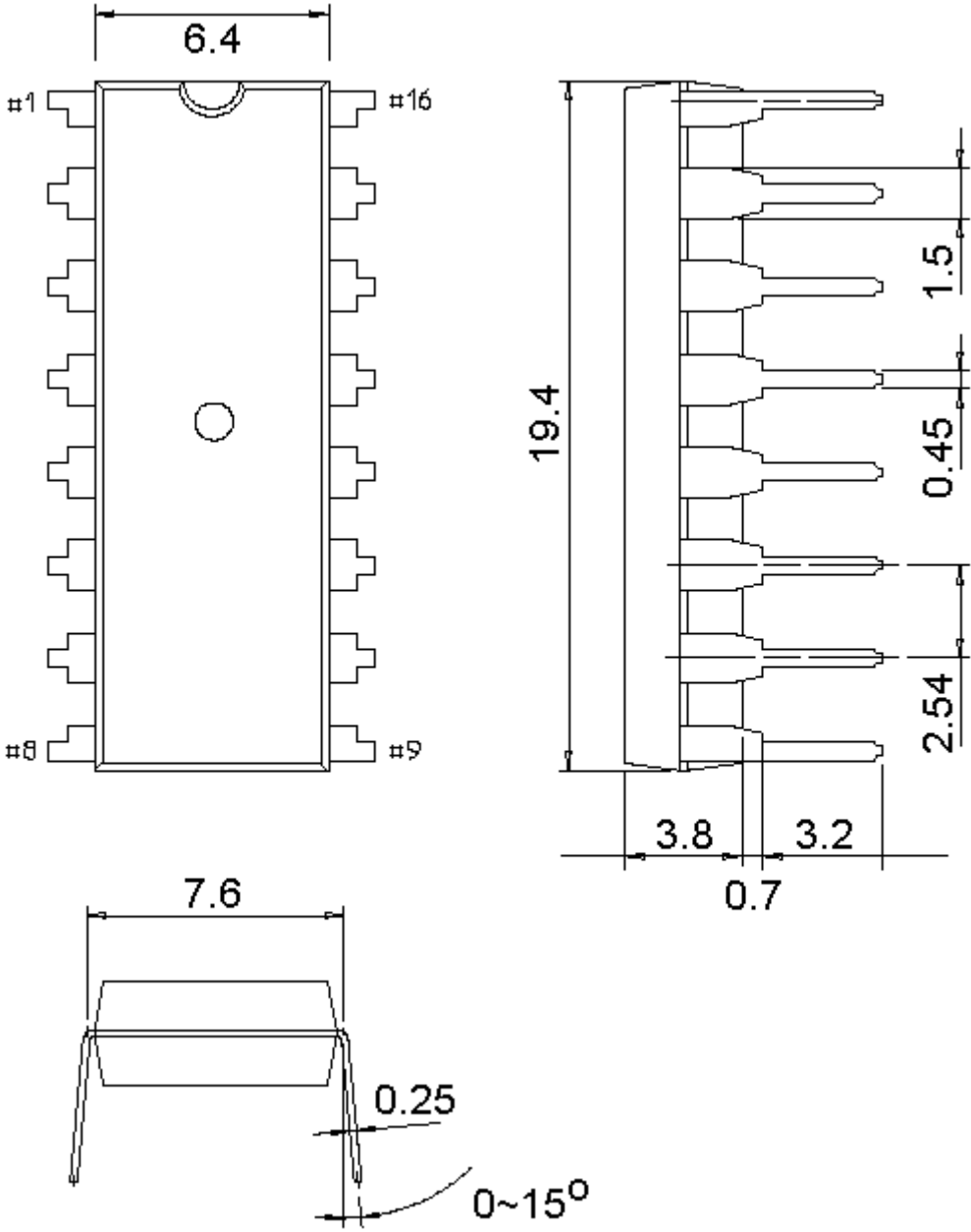

DIP18

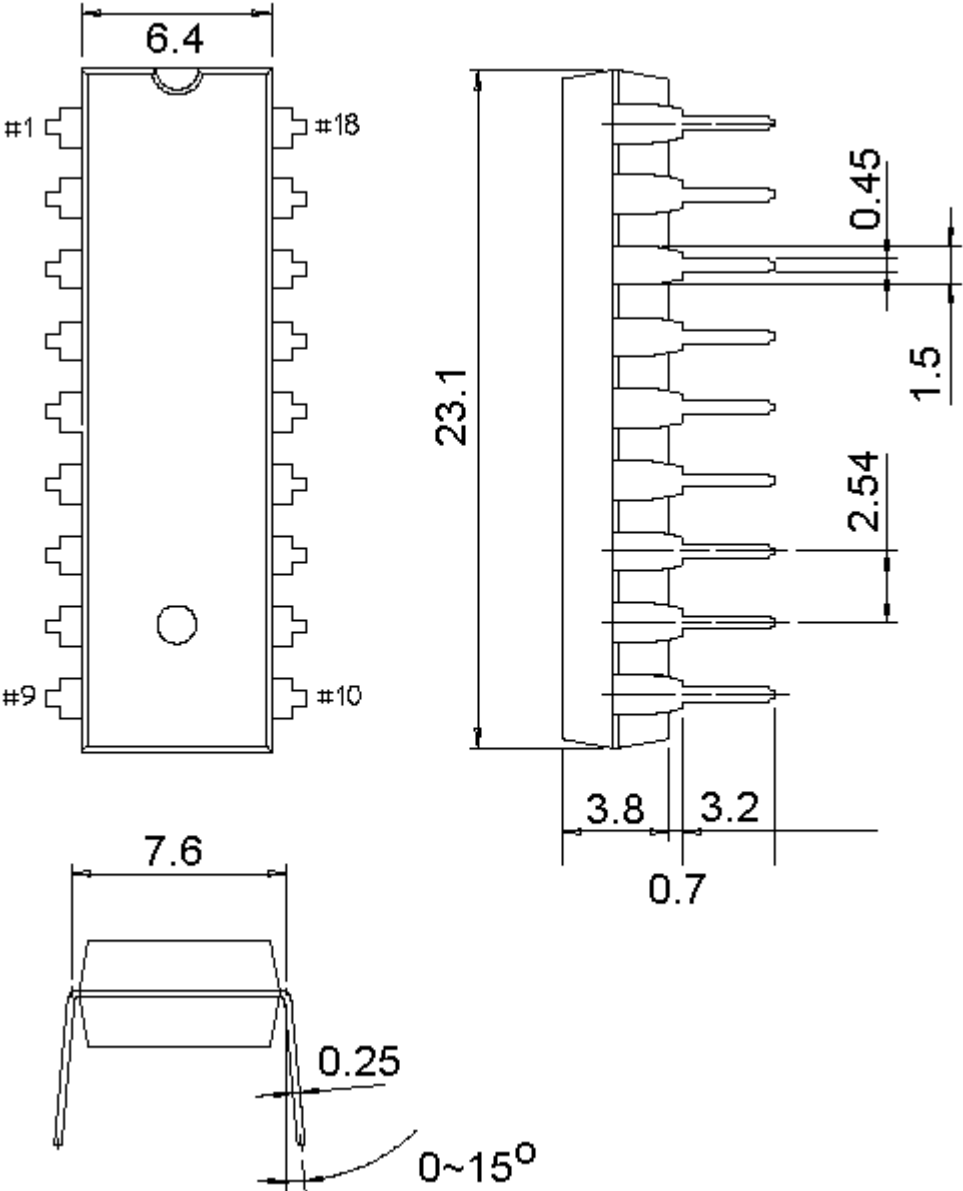

DIP20

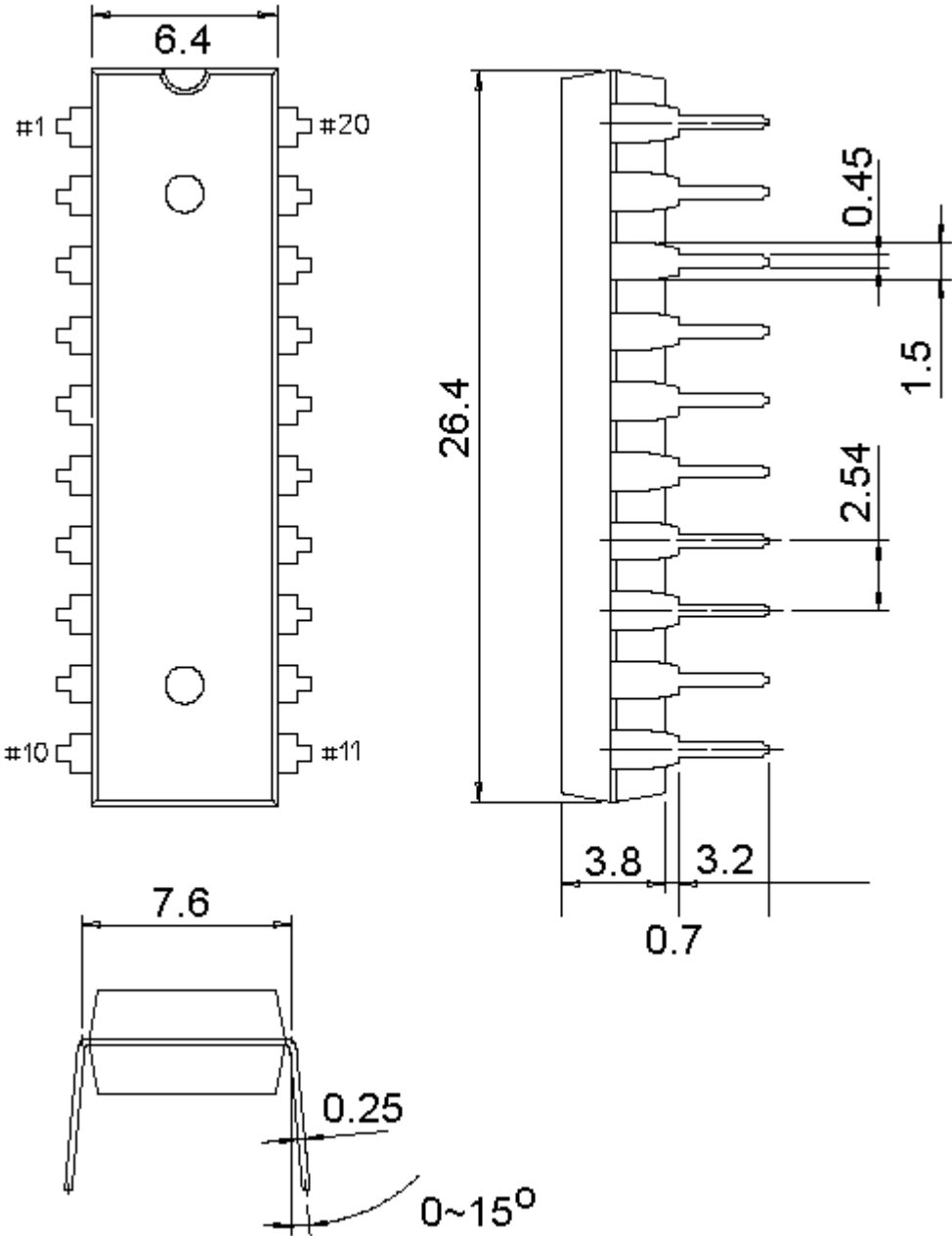

DIP24S (SKDIP24、DIP24-300mil)

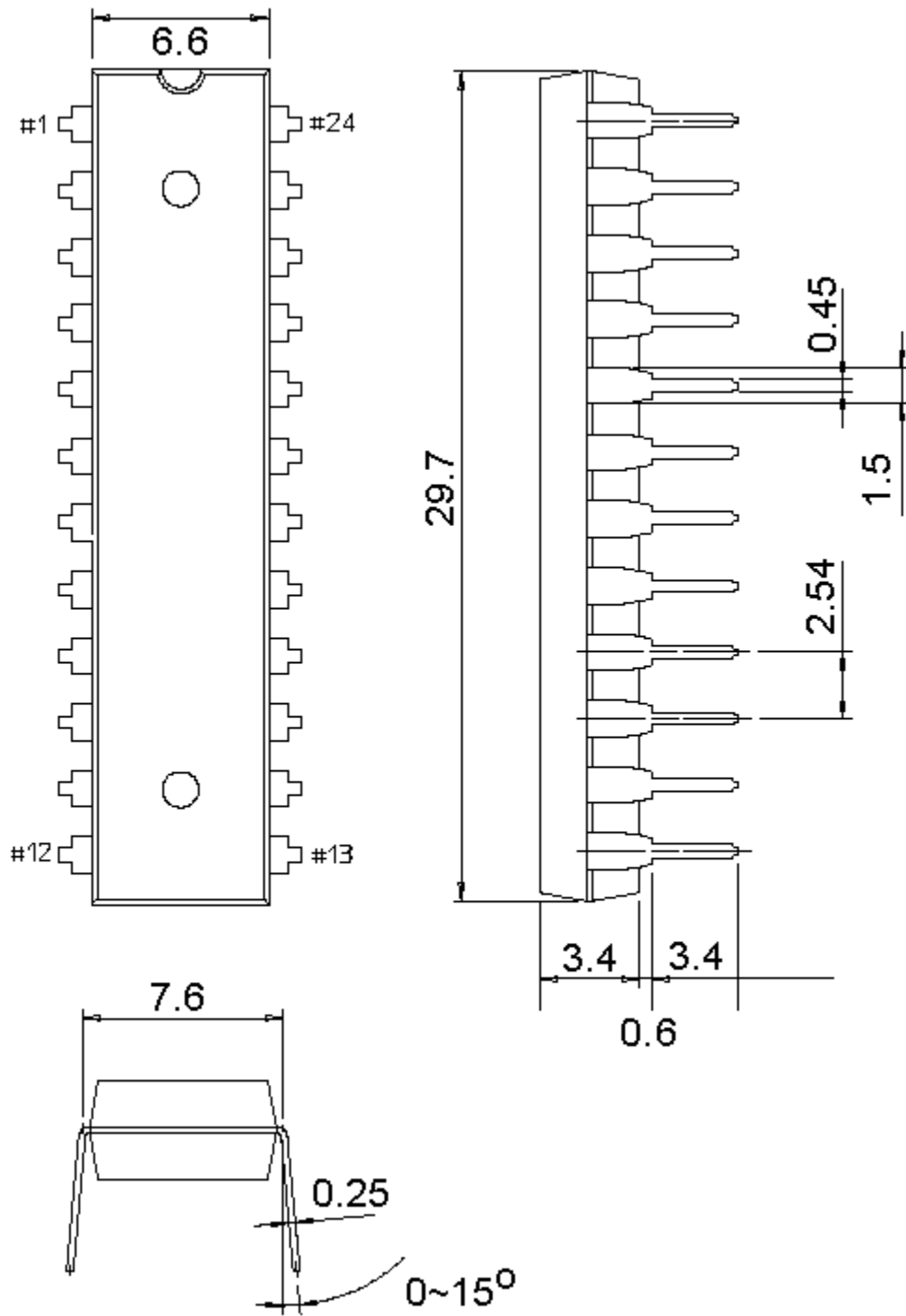

DIP28S (SKDIP28、DIP28-300mil)

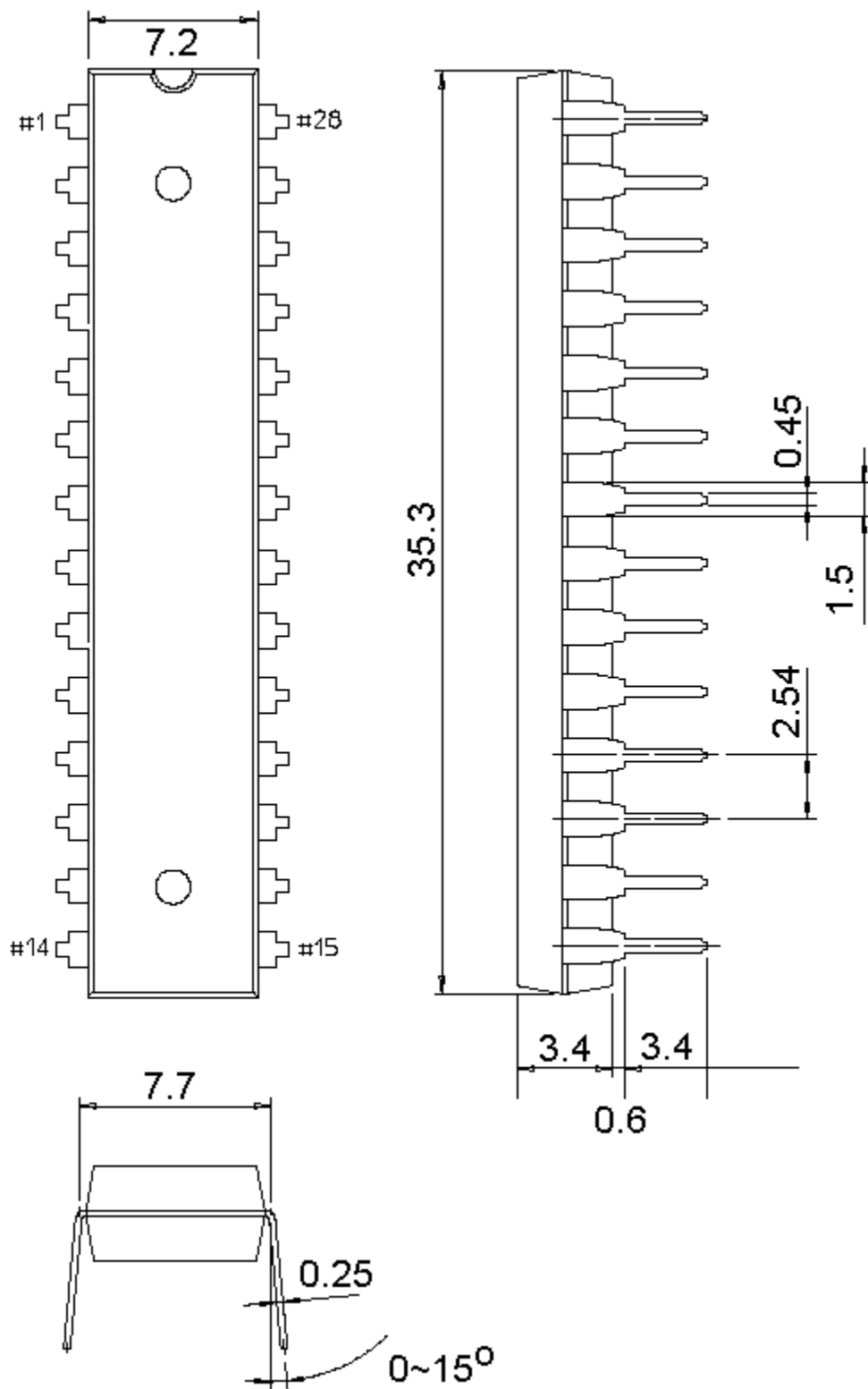

DIP28 (DIP28W、DIP28-600mil)

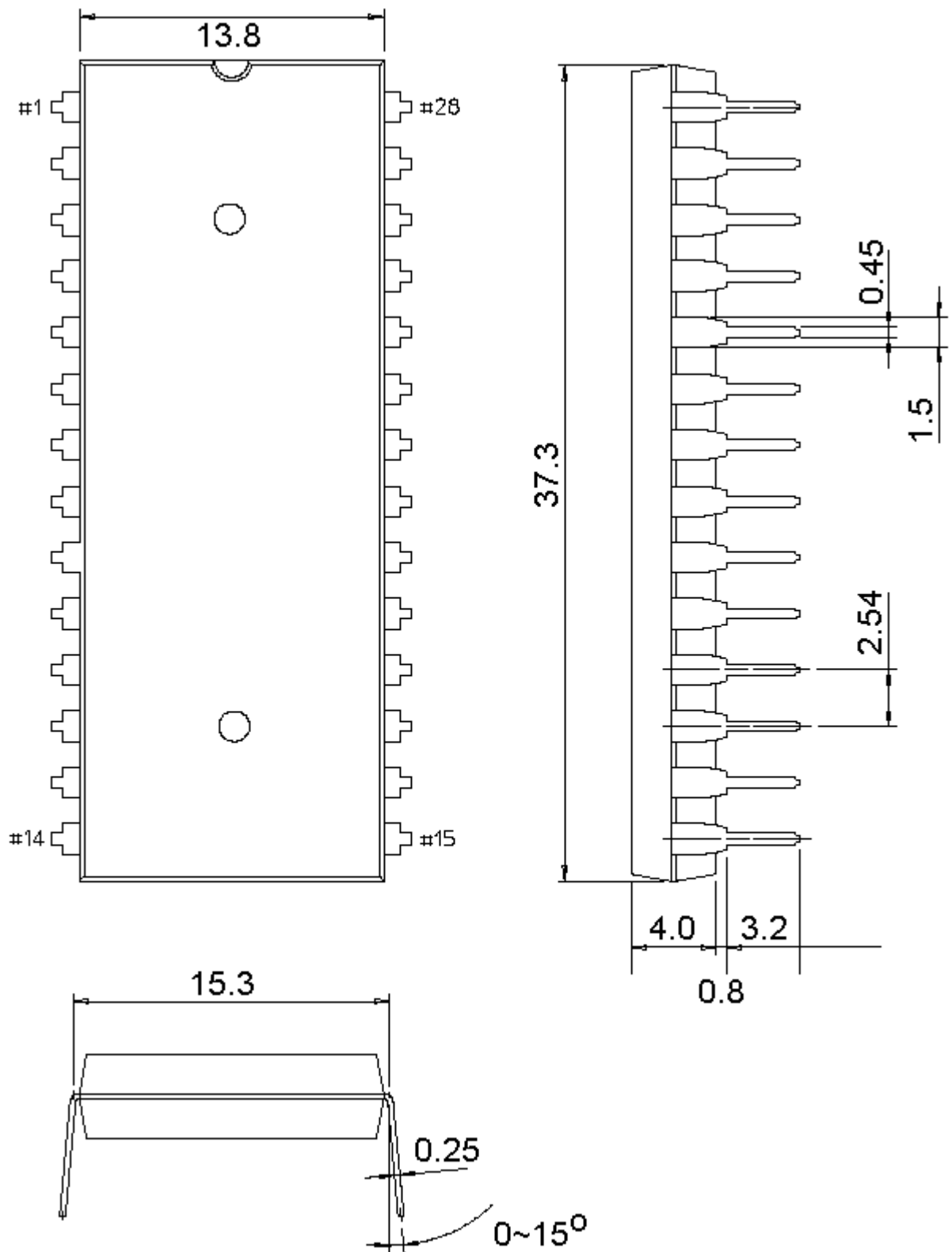

SDIP28 (SDIP28-400mil)

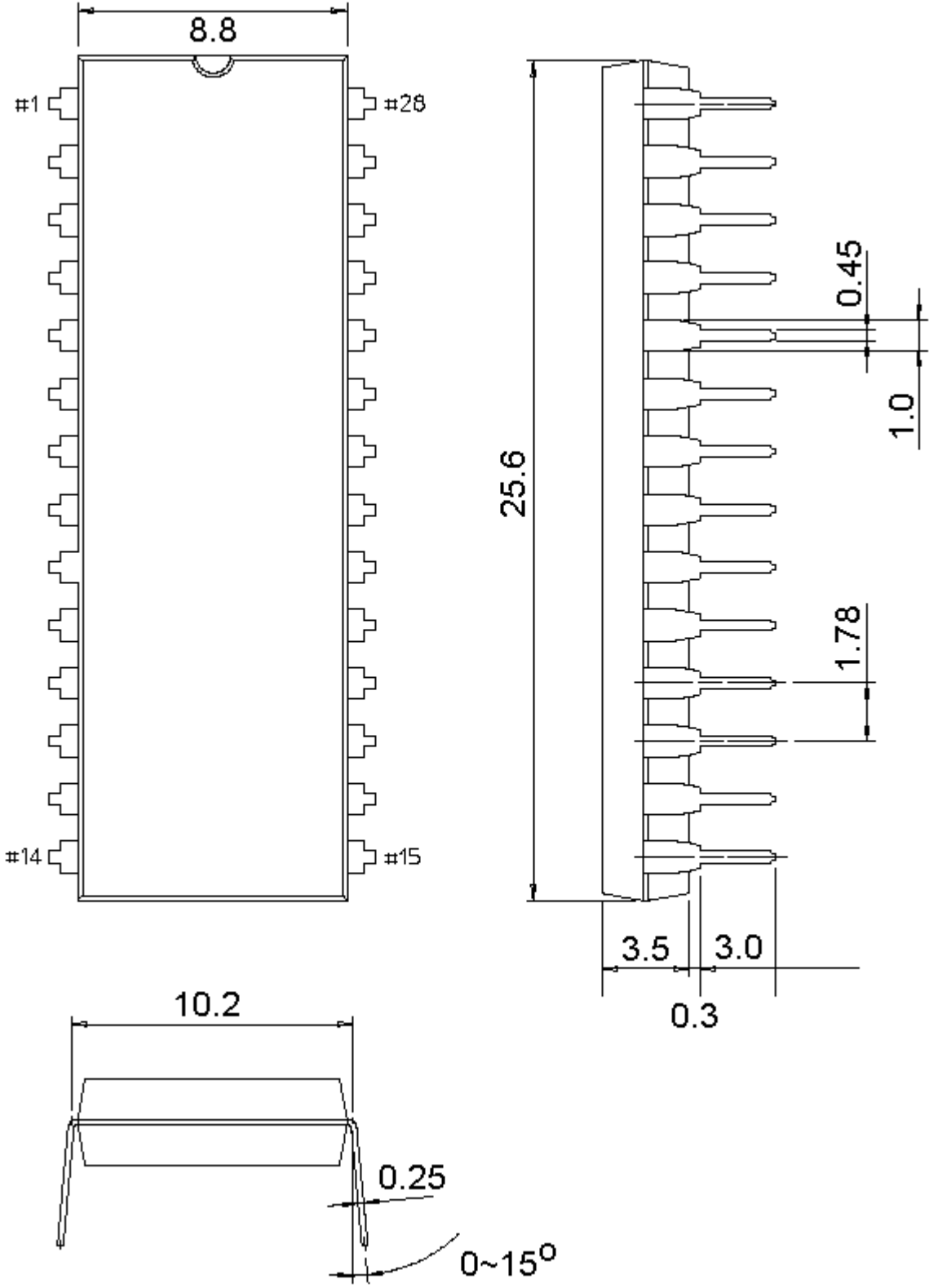

SDIP32 (SDIP32-400mil)

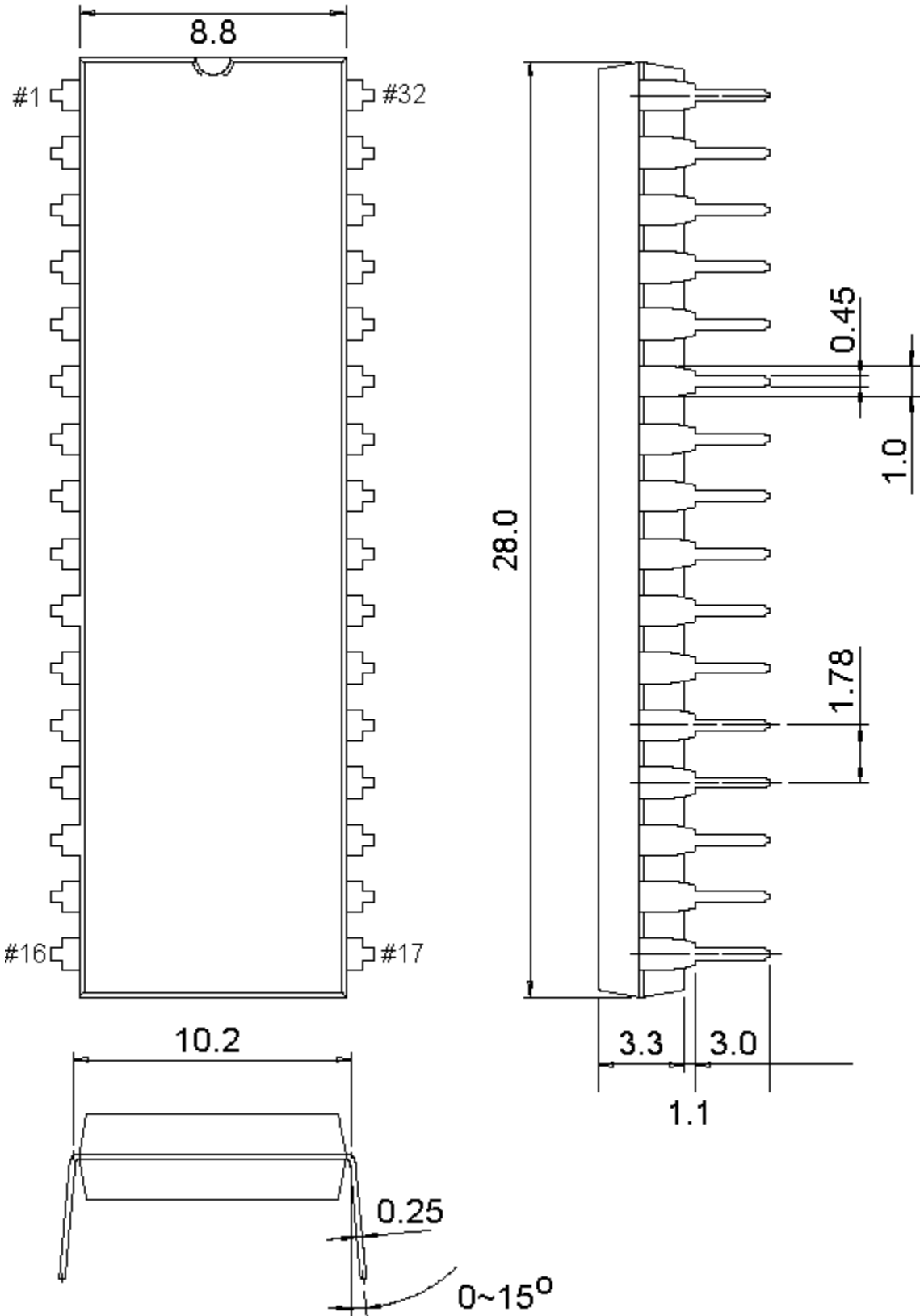

SOP 类 (SOIC)

SOP8、eSOP8

eSOP8 Exposed Pad: 2.1*3.3、2.1*2.1

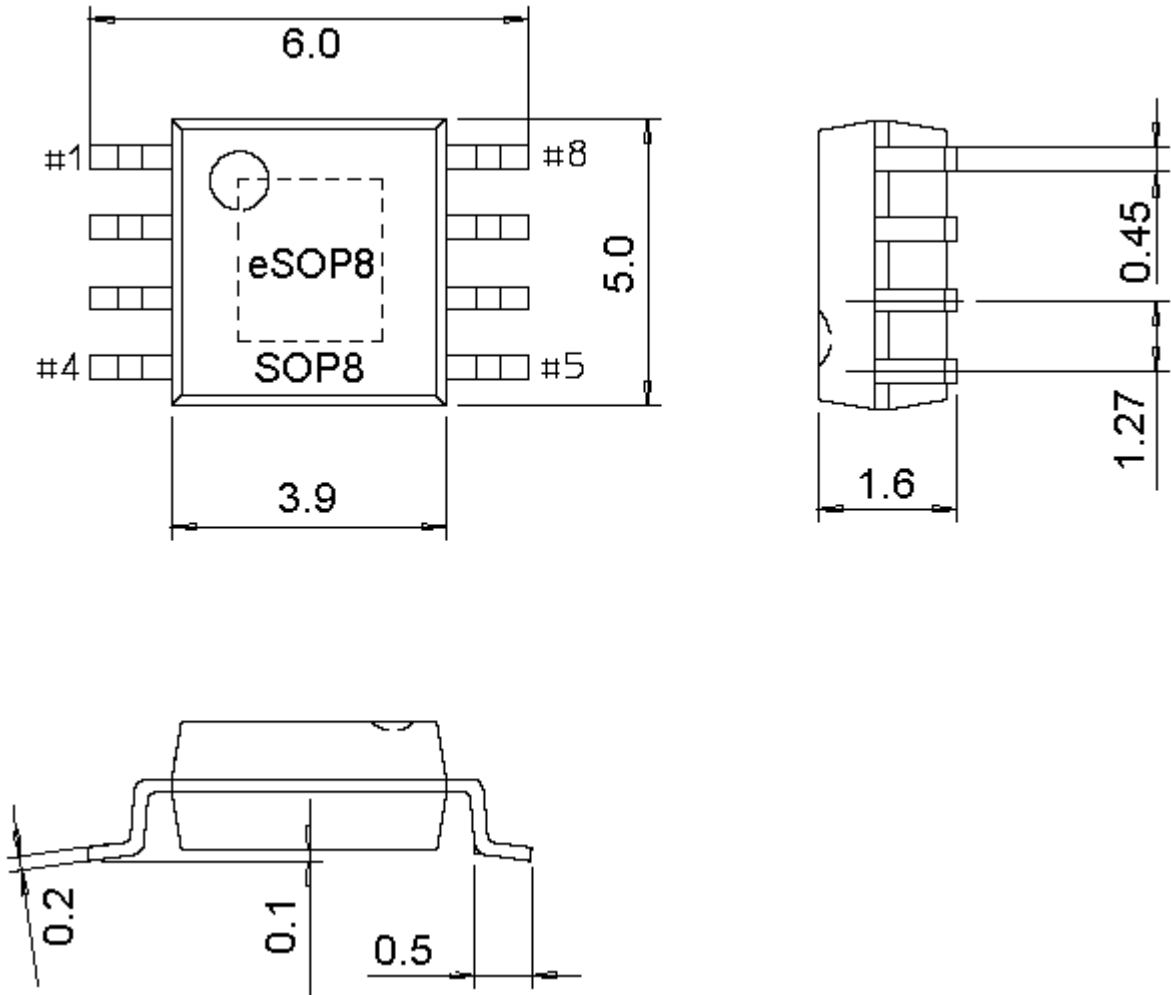

SOP14

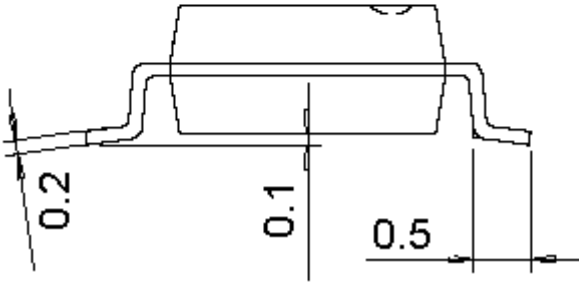
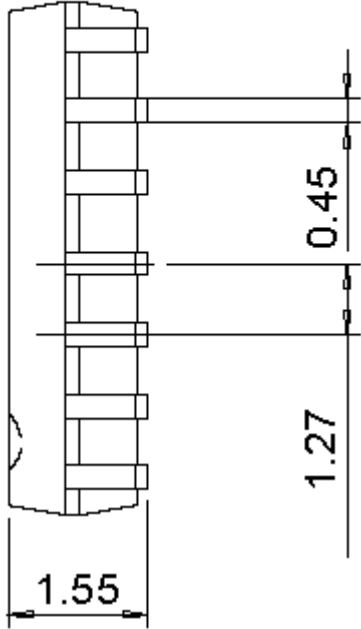
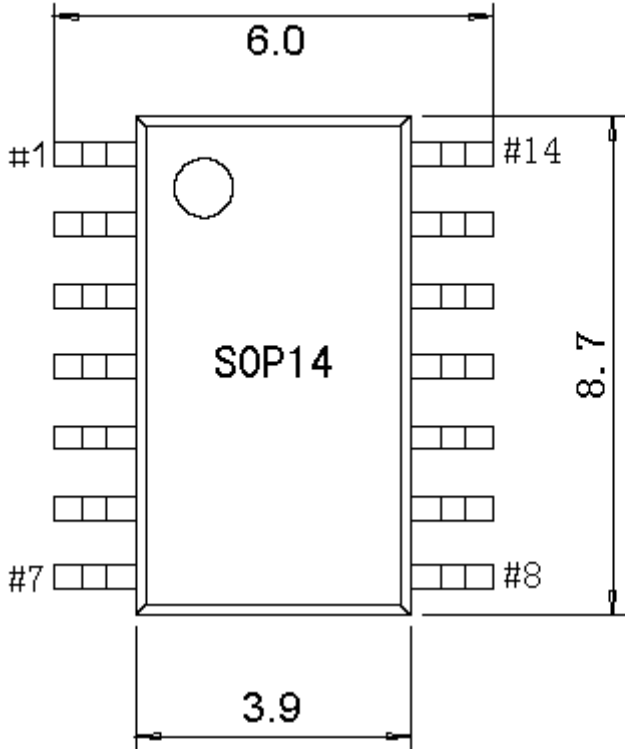

SOP16 (SOP16-150mil)

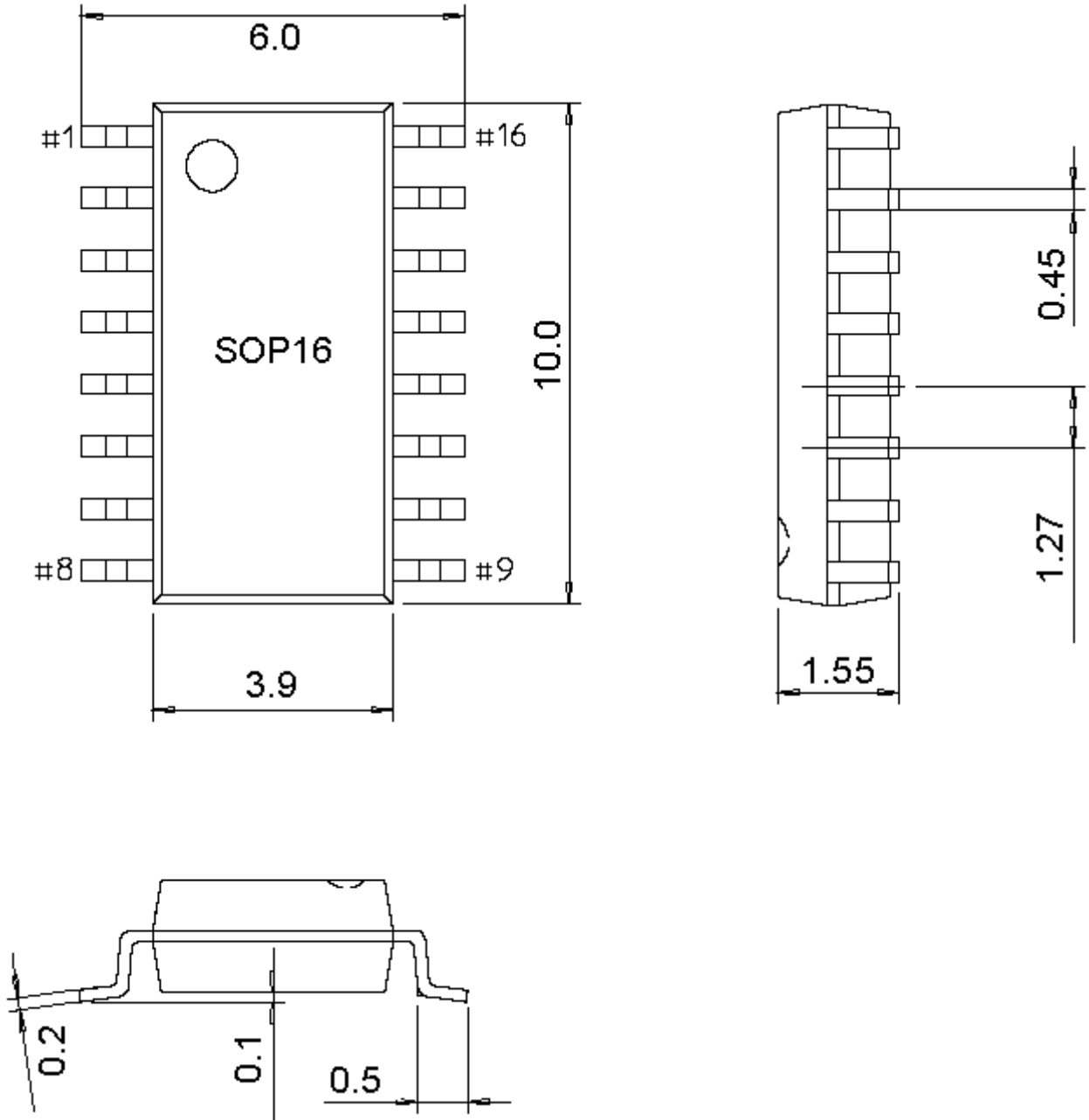

SOP18

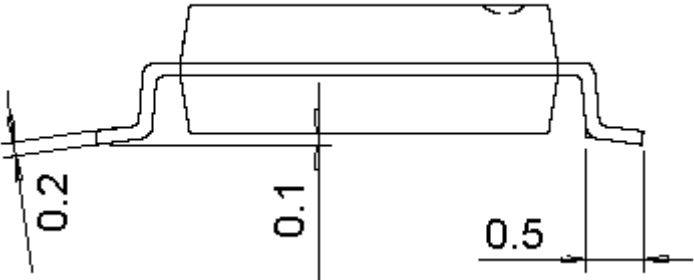
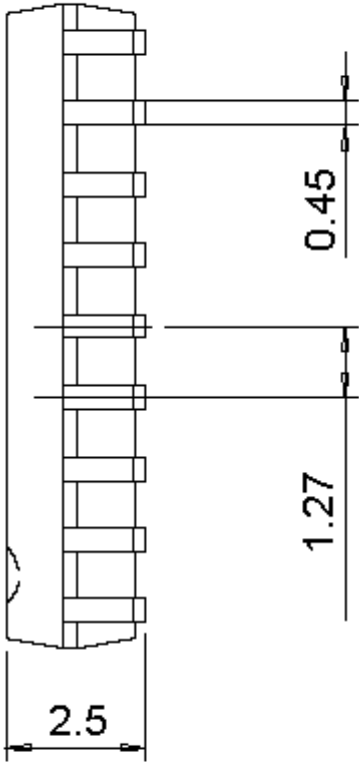
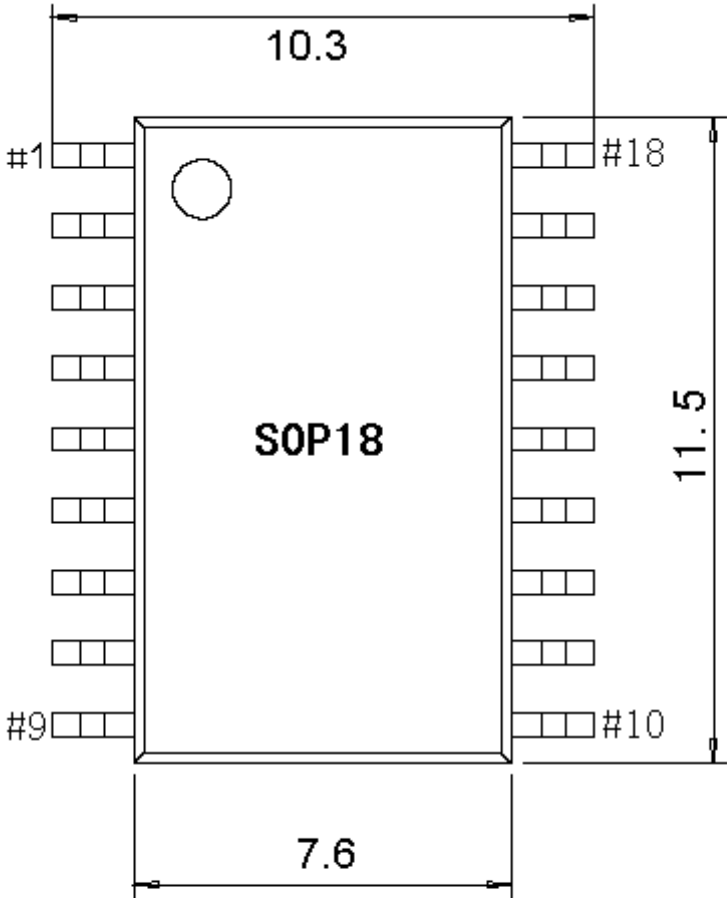

SOP20

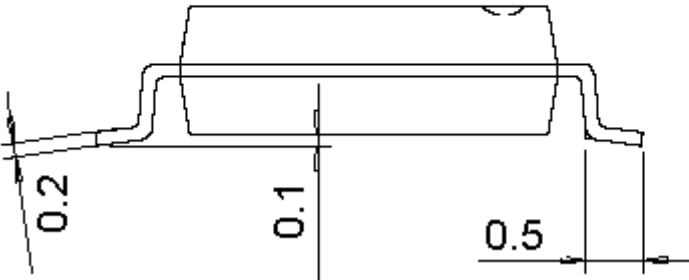
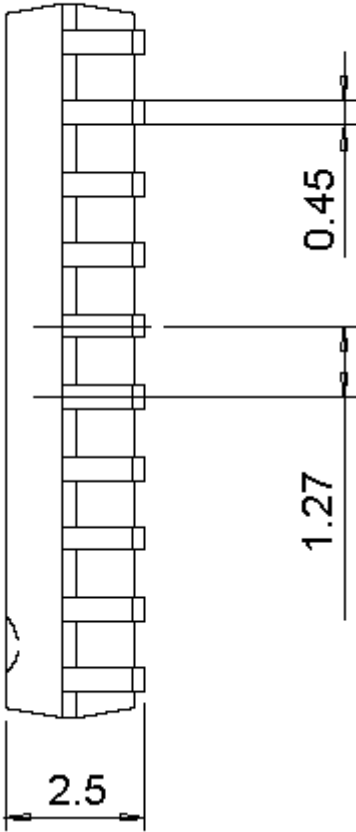
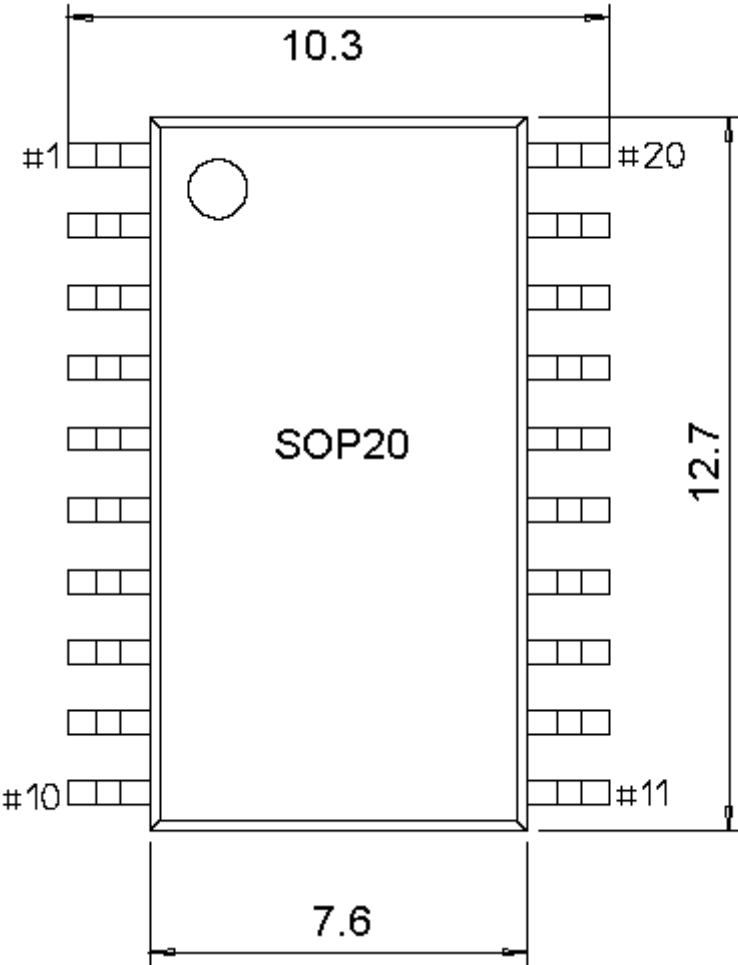

SOP24

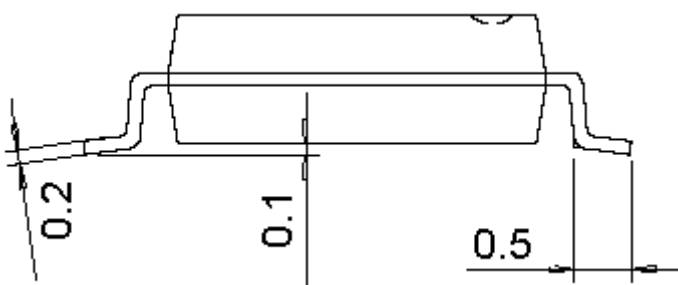
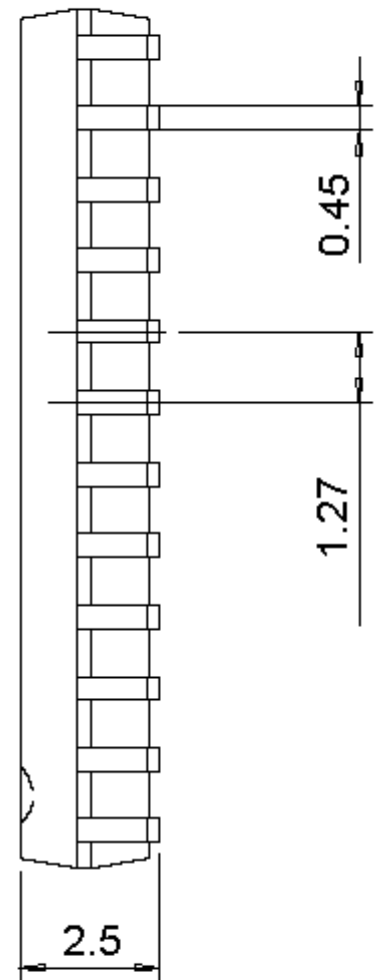
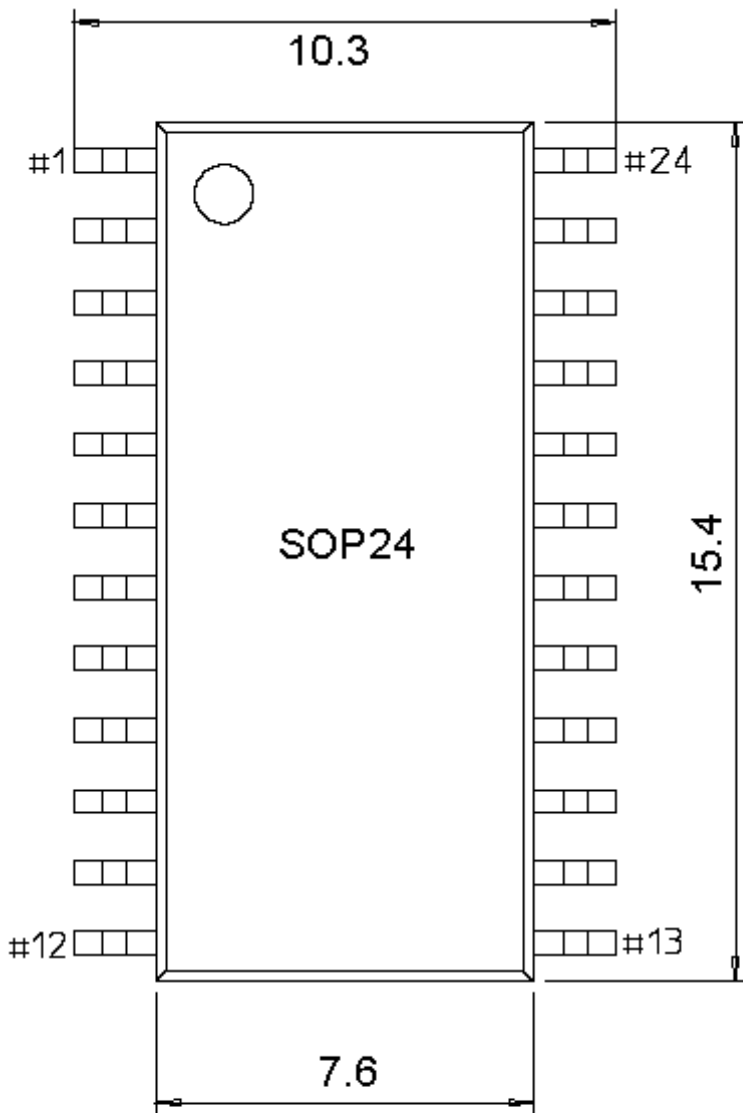

SOP28

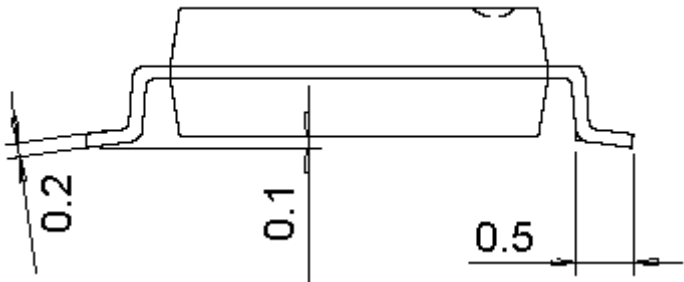
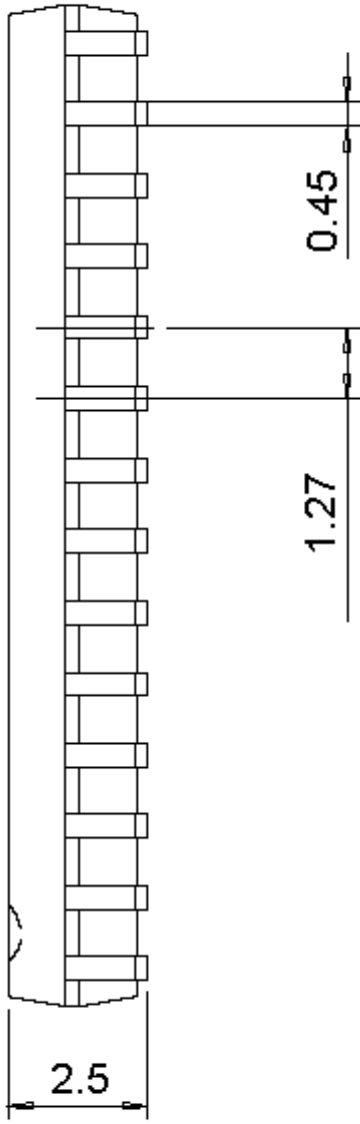
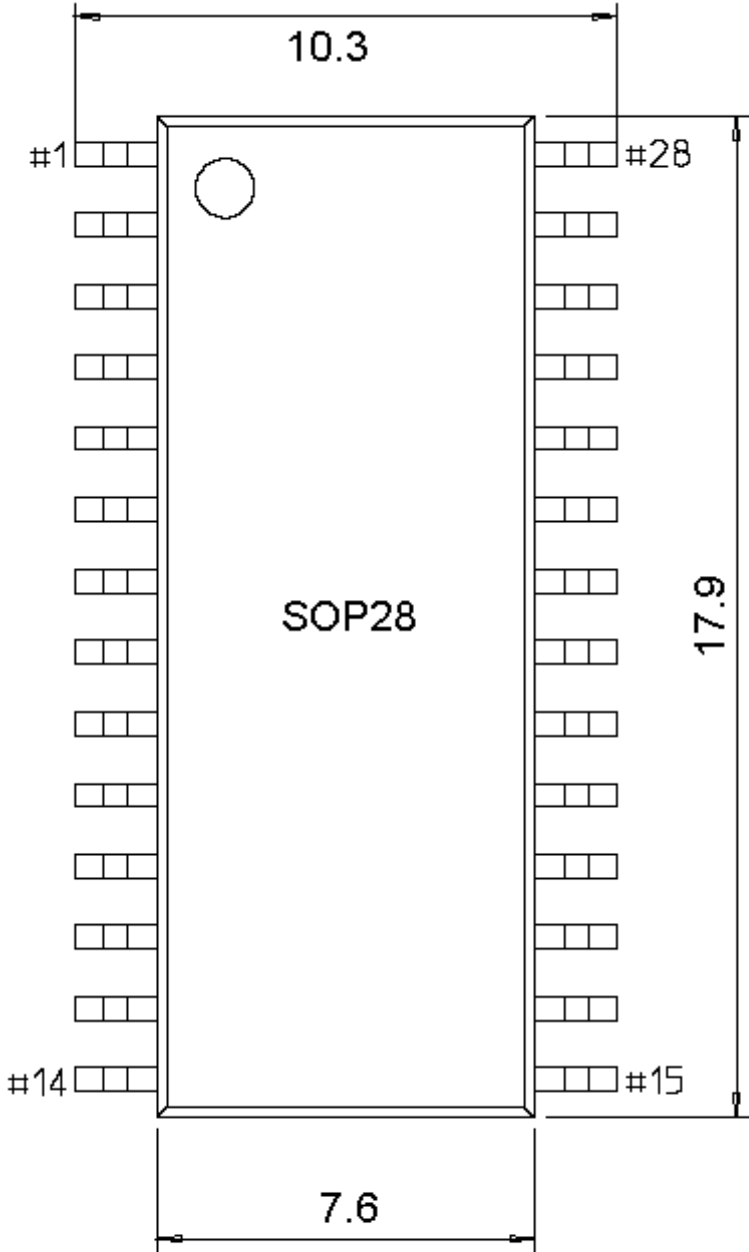

SOP30

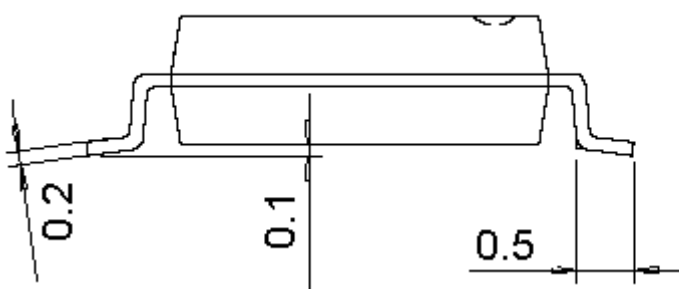
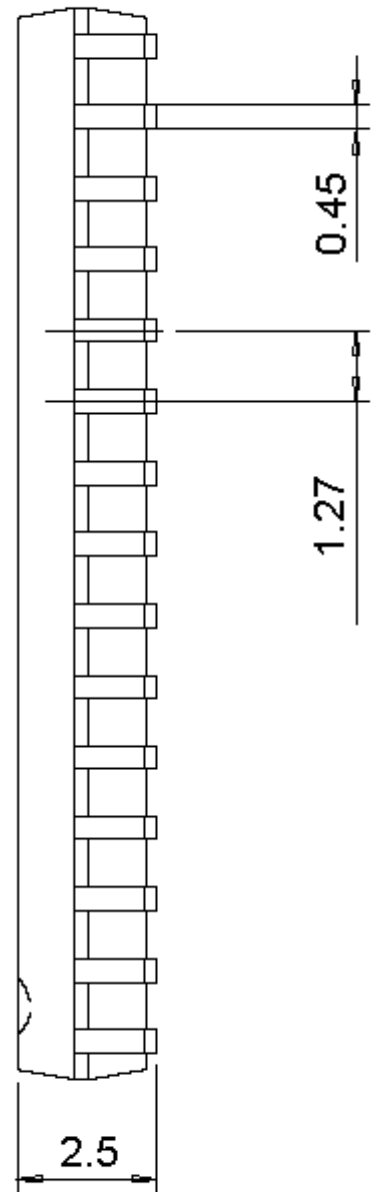
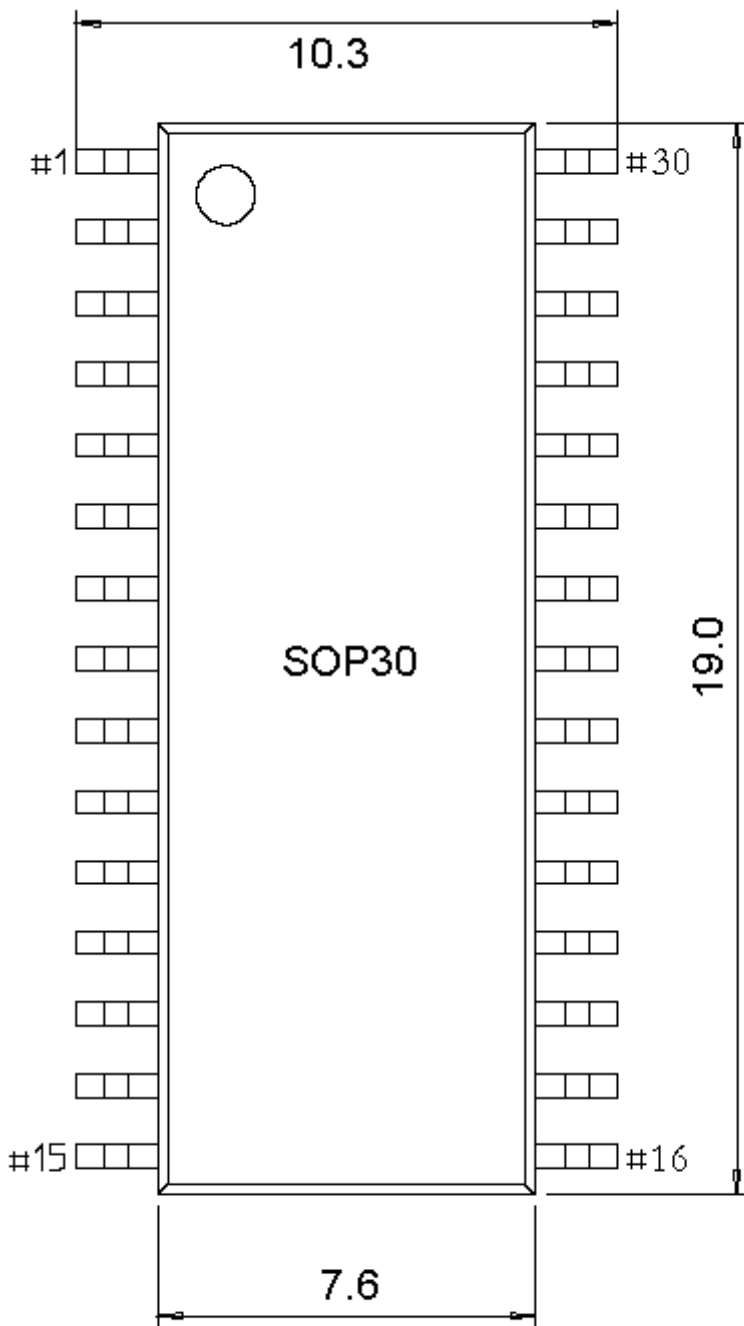

SSOP 类

SSOP10 (SSOP10-150mil-1.00)、eSSOP10

eSSOP10 Exposed Pad: 2.1*3.3

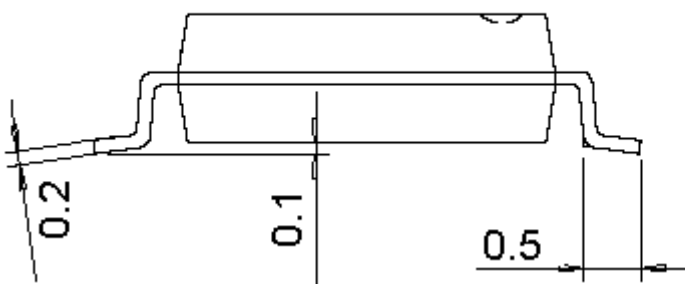
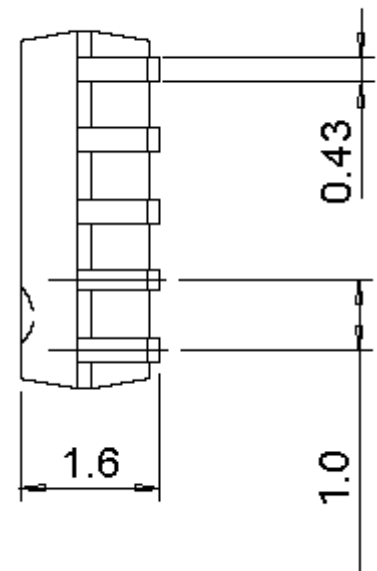
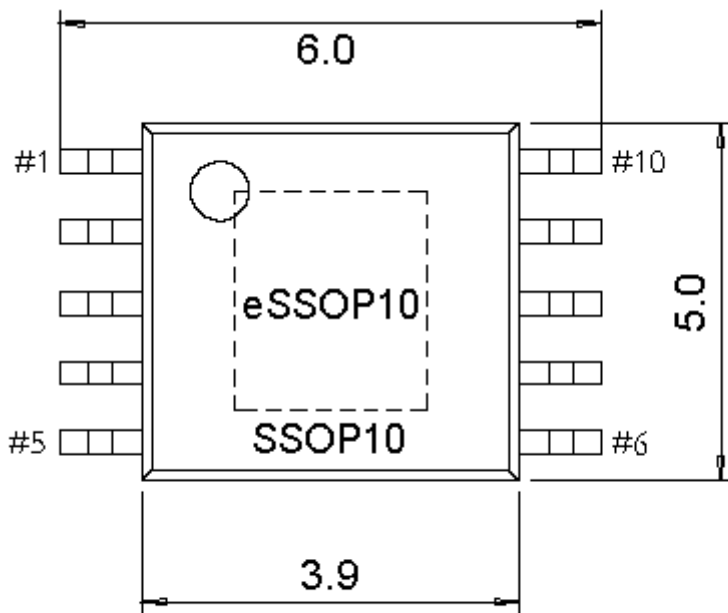

SSOP16 (SSOP16-209mil-0.65)

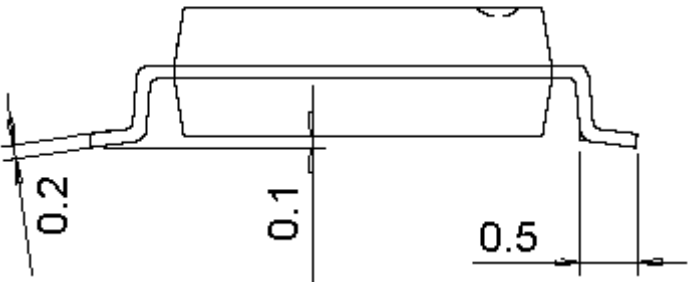
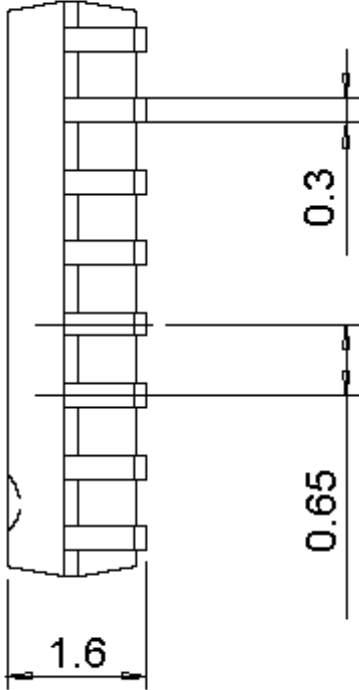
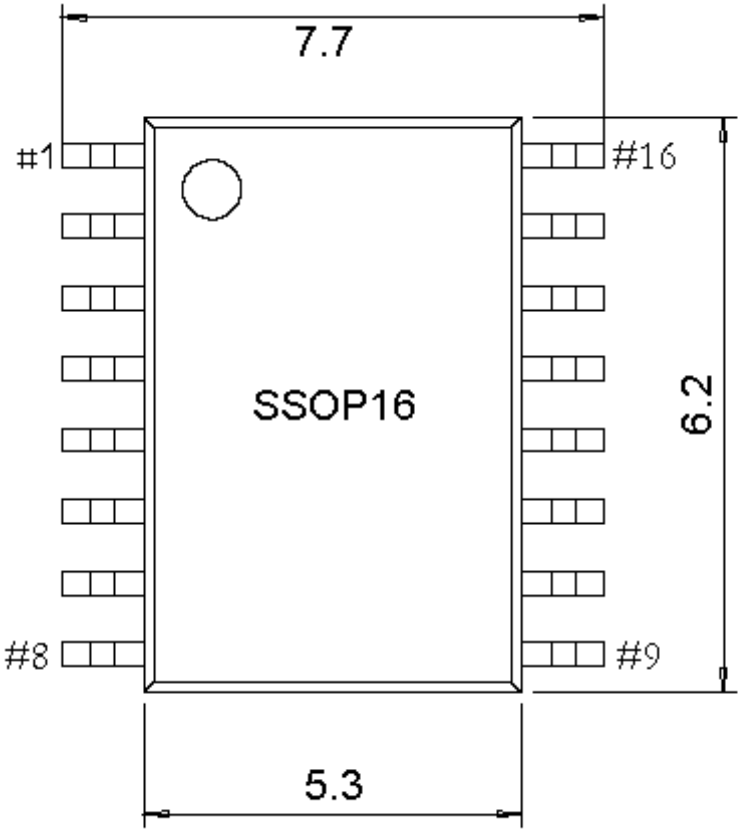

SSOP20 (SSOP20-209mil-0.65)

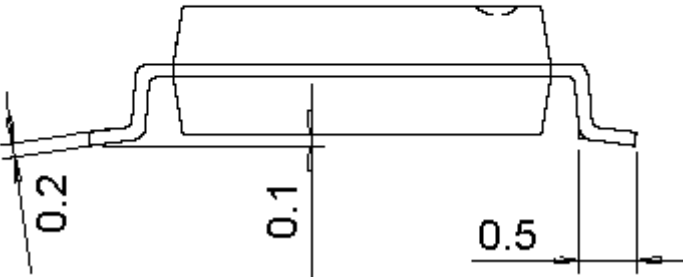
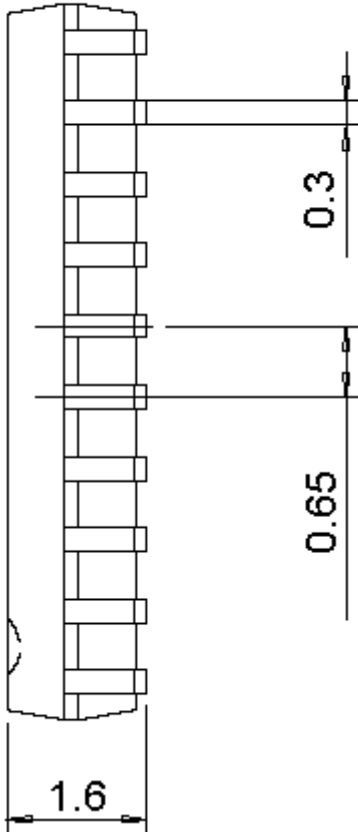
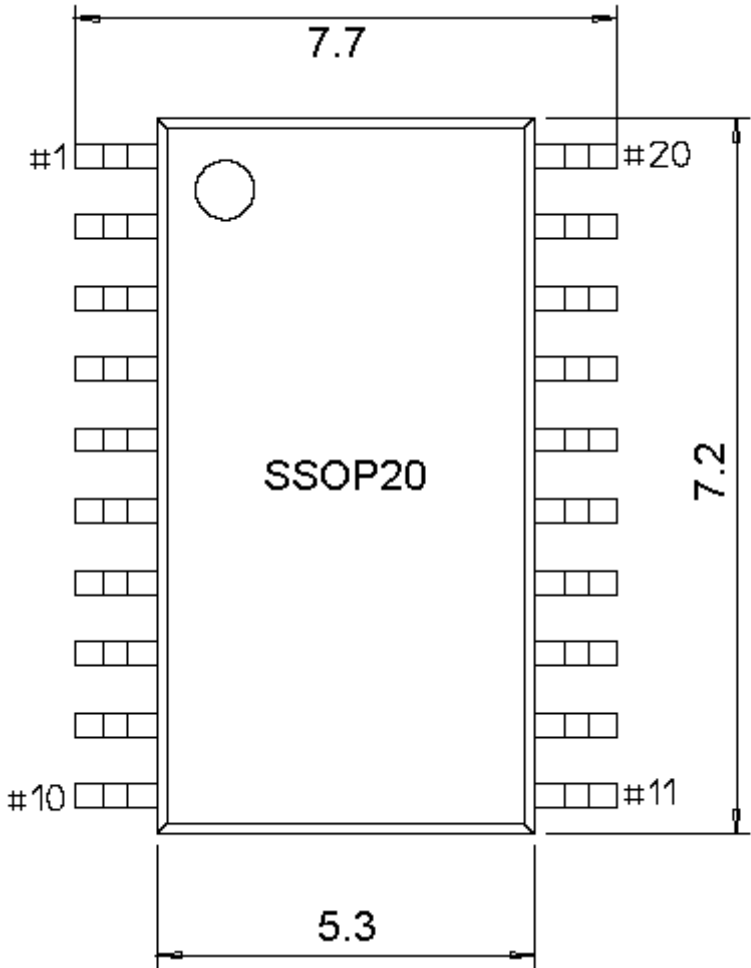

SSOP24 (SSOP24-209mil-0.65)

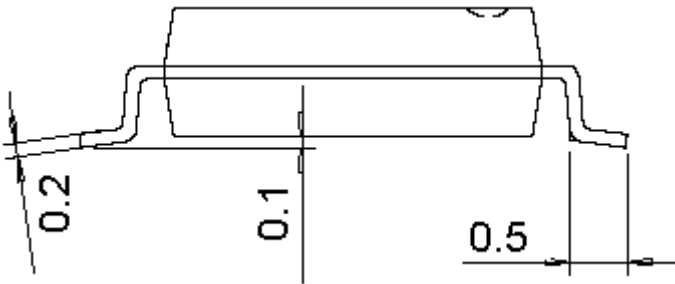
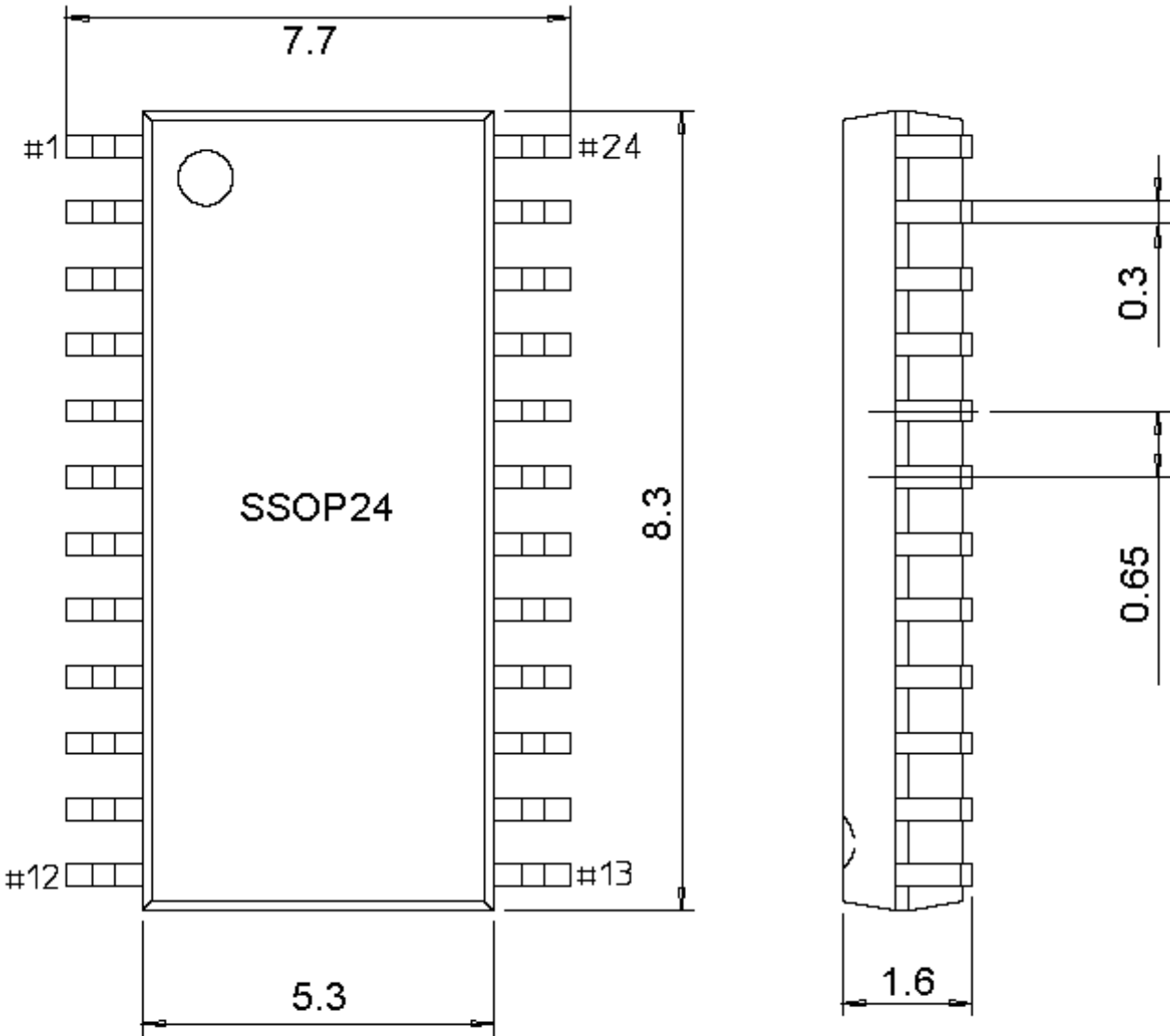

SSOP28 (SSOP28-209mil-0.65)

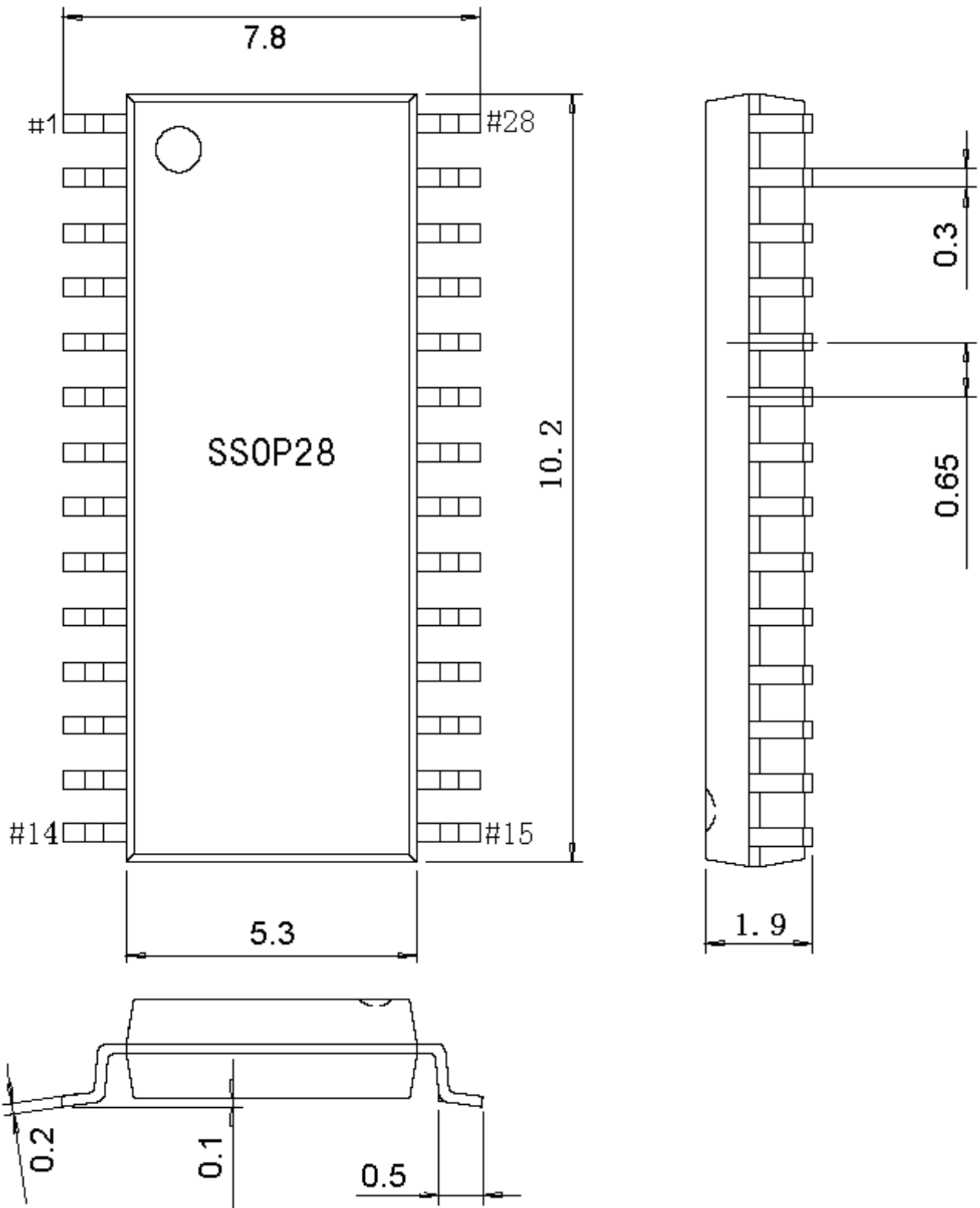

MSOP 类

MSOP10

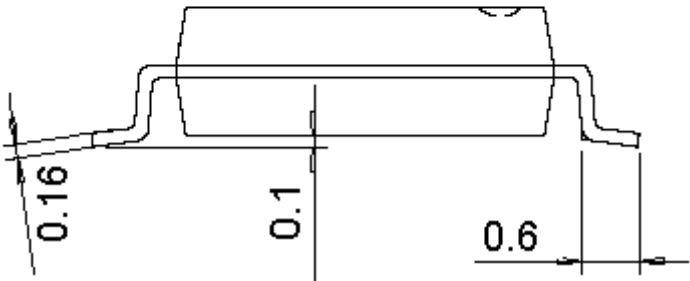
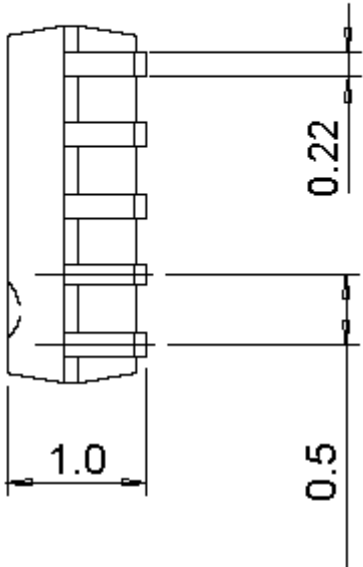
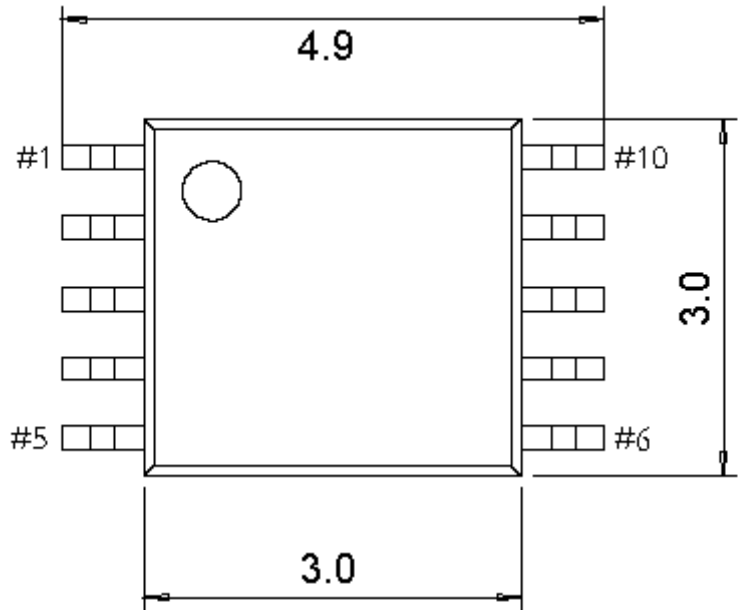

TSSOP 类 (4.4mm, 173mil)

TSSOP8

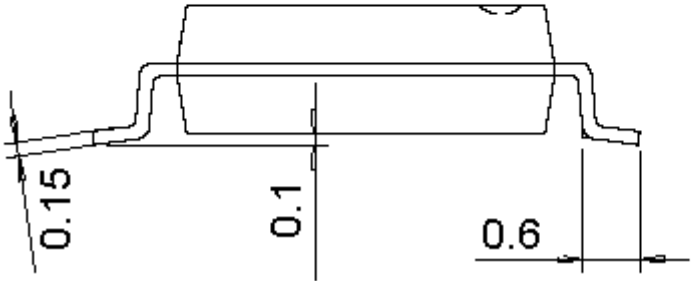
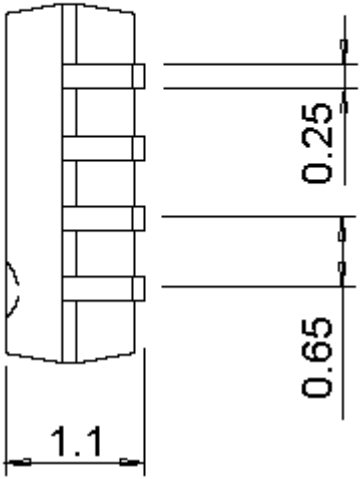
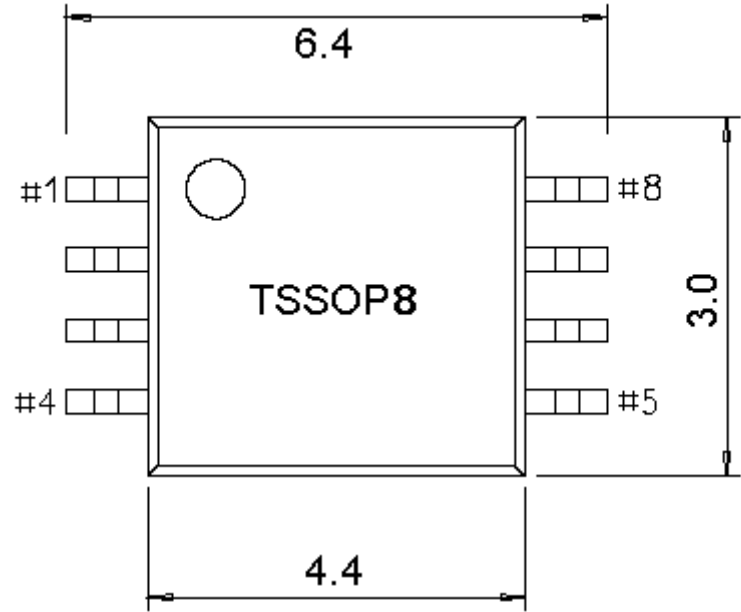

TSSOP14、eTSSOP14

eTSSOP14 Exposed Pad: 3.0*3.0

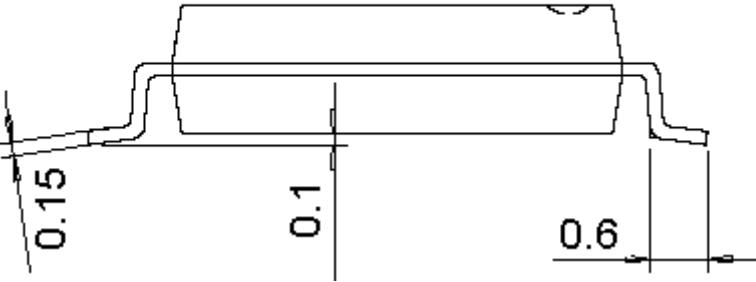
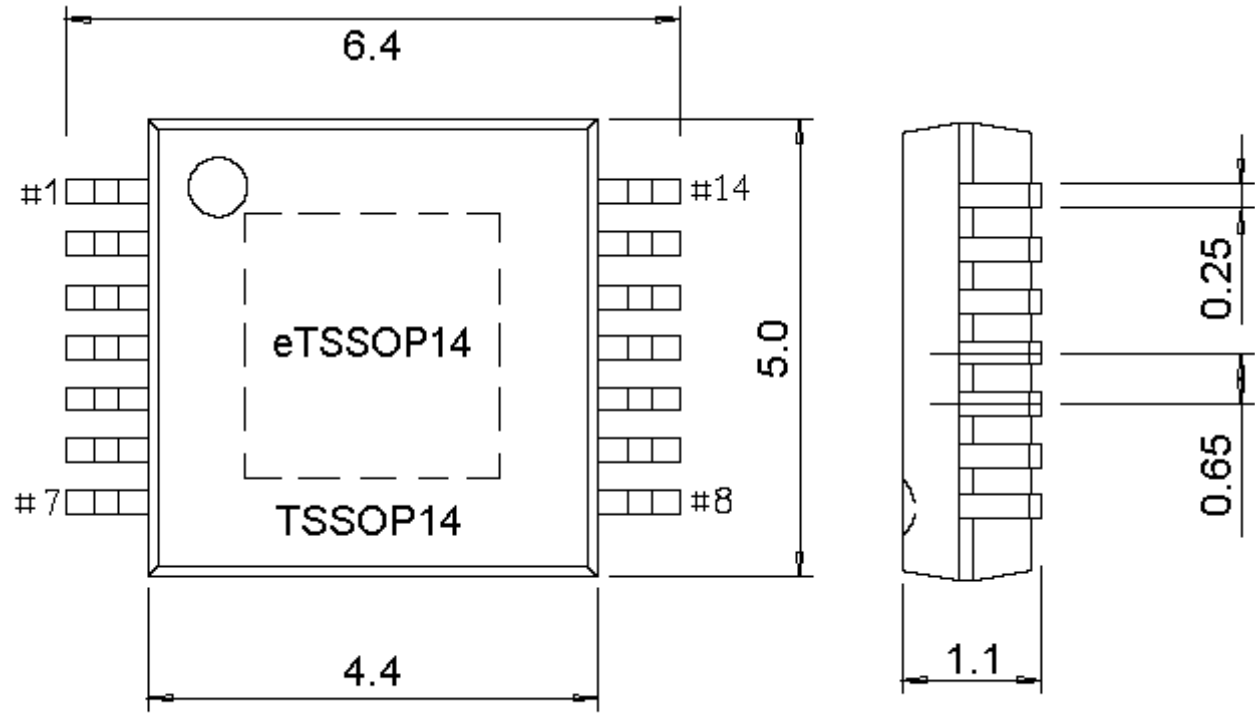

TSSOP16、eTSSOP16

eTSSOP16 Exposed Pad: 2.8*3.0

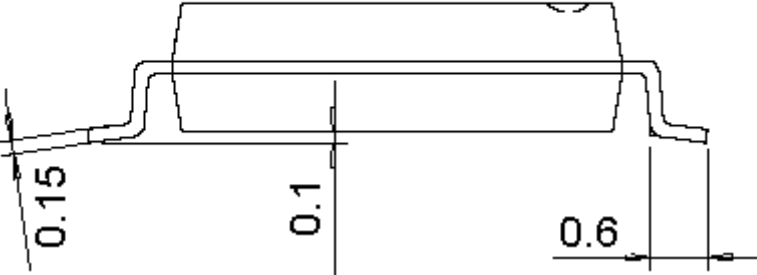
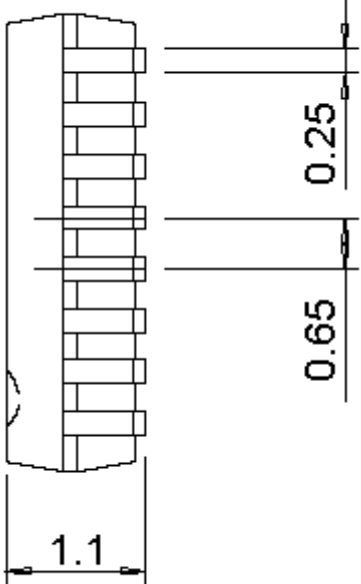
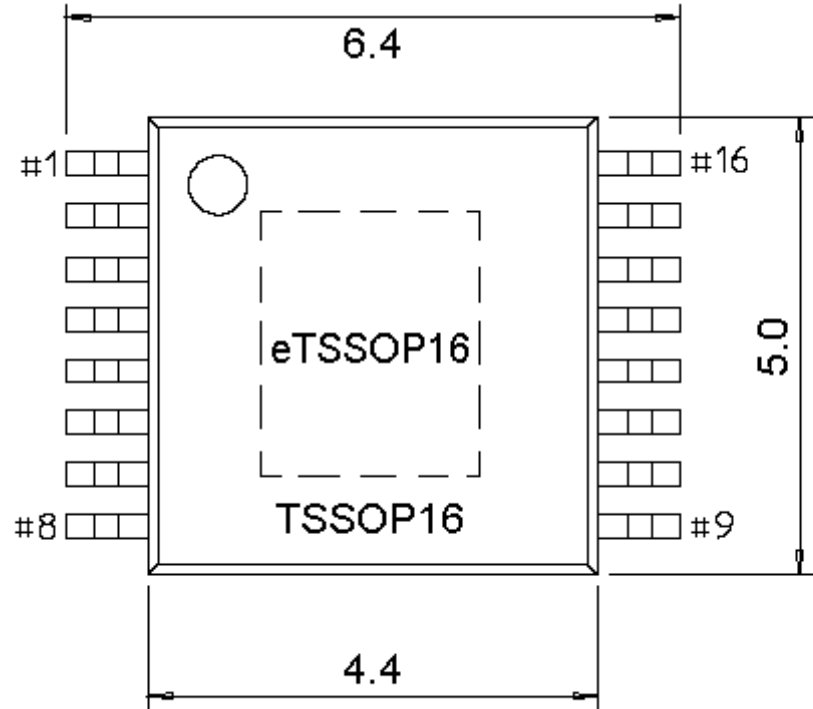

TSSOP20、eTSSOP20

eTSSOP20 Exposed Pad: 3.0*4.2

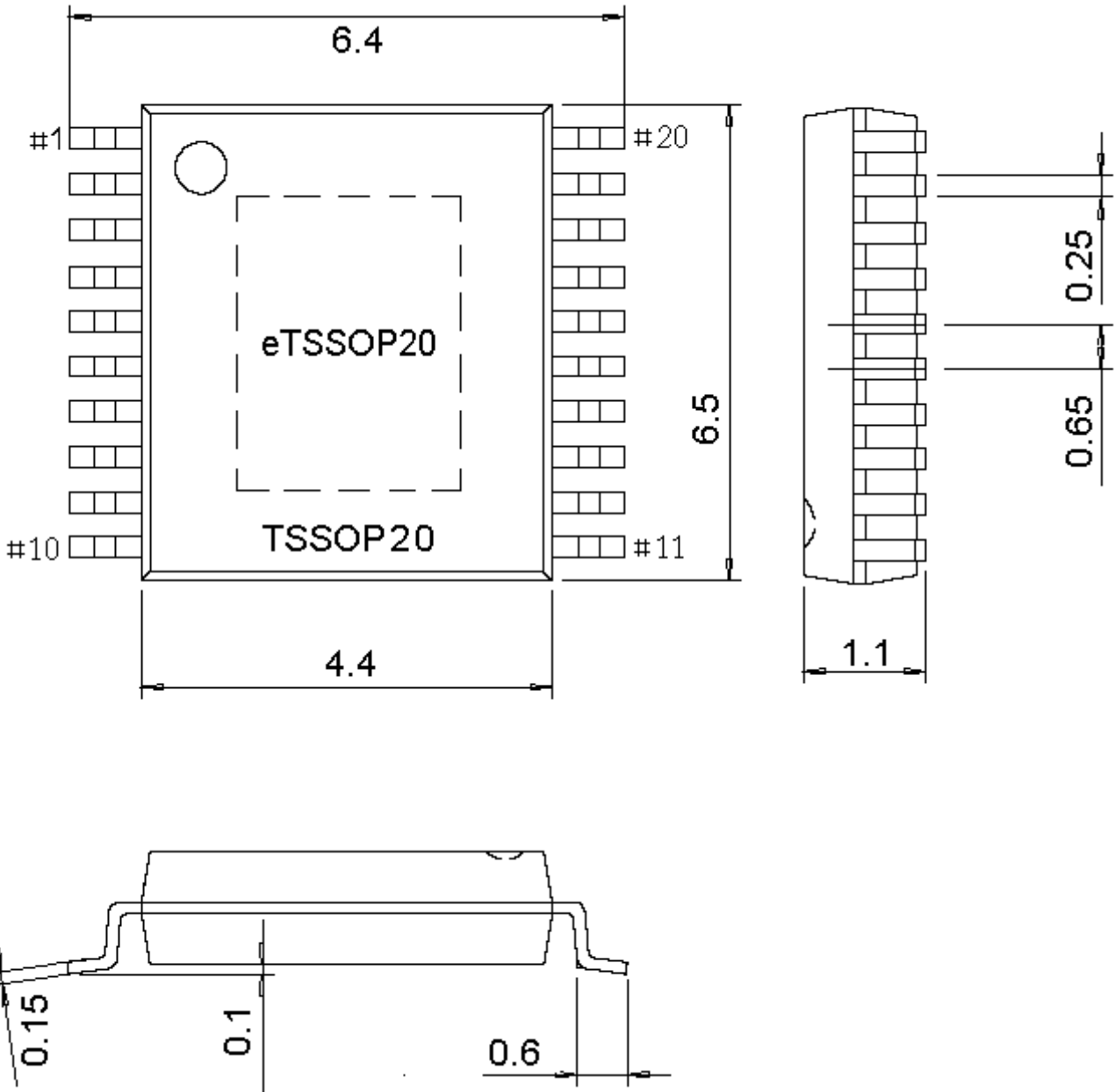

TSSOP24

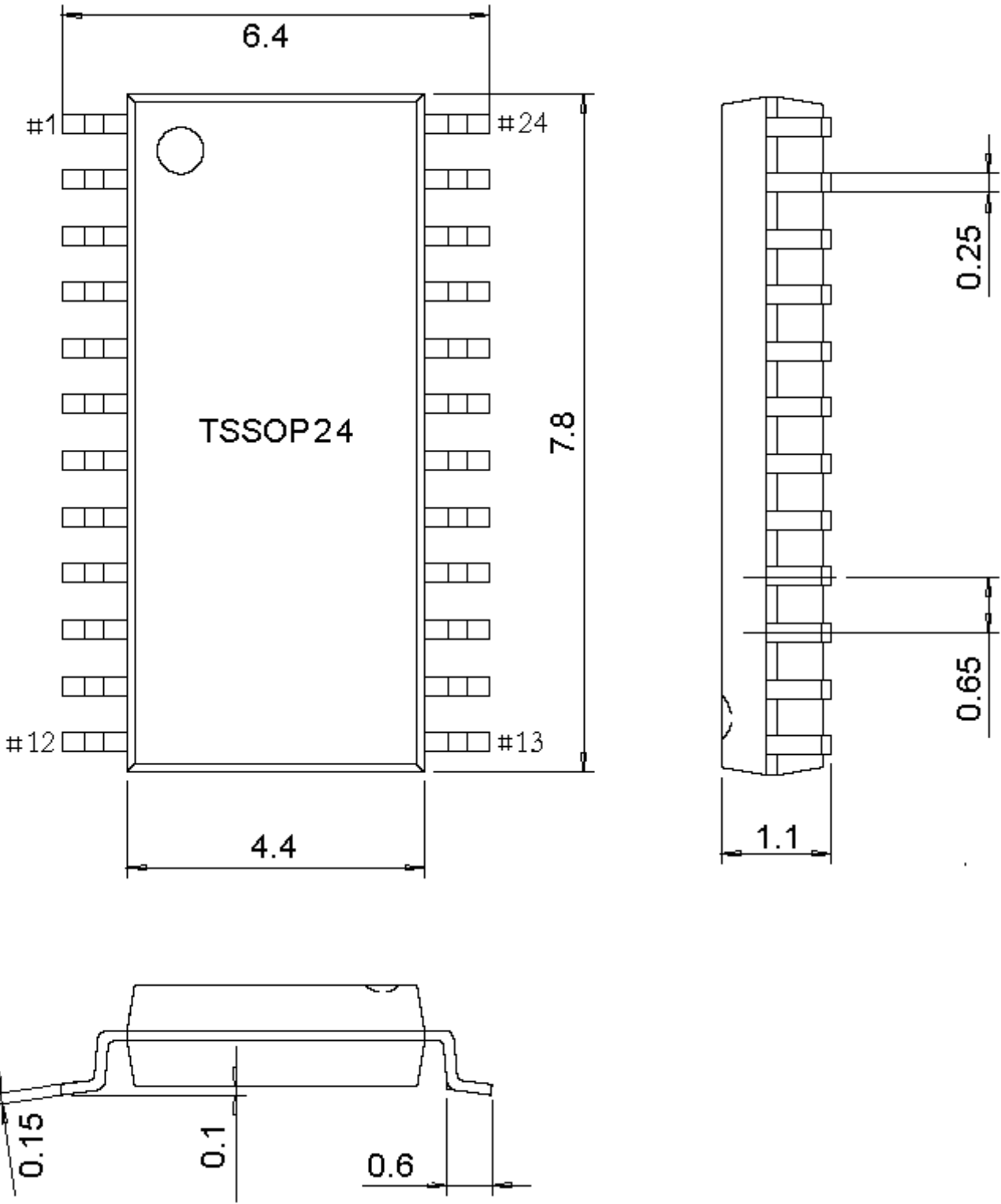

TSSOP28

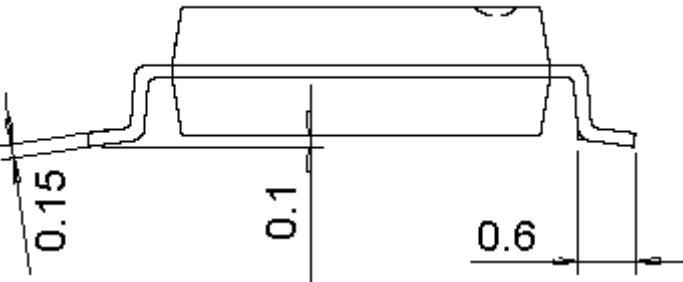
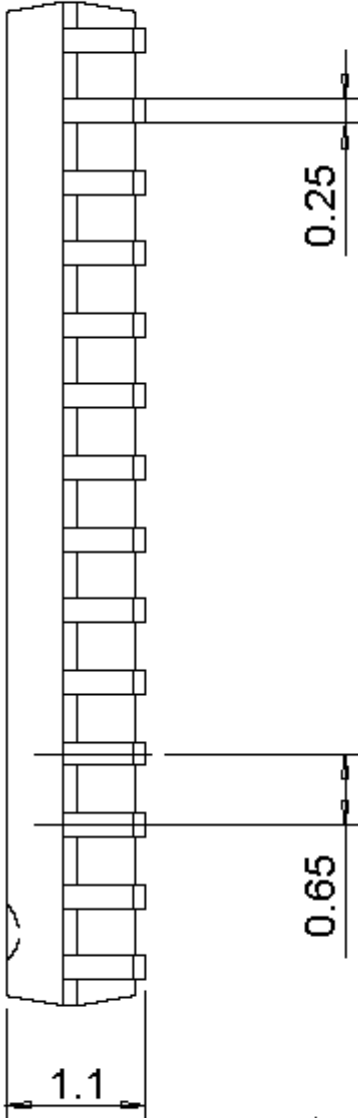
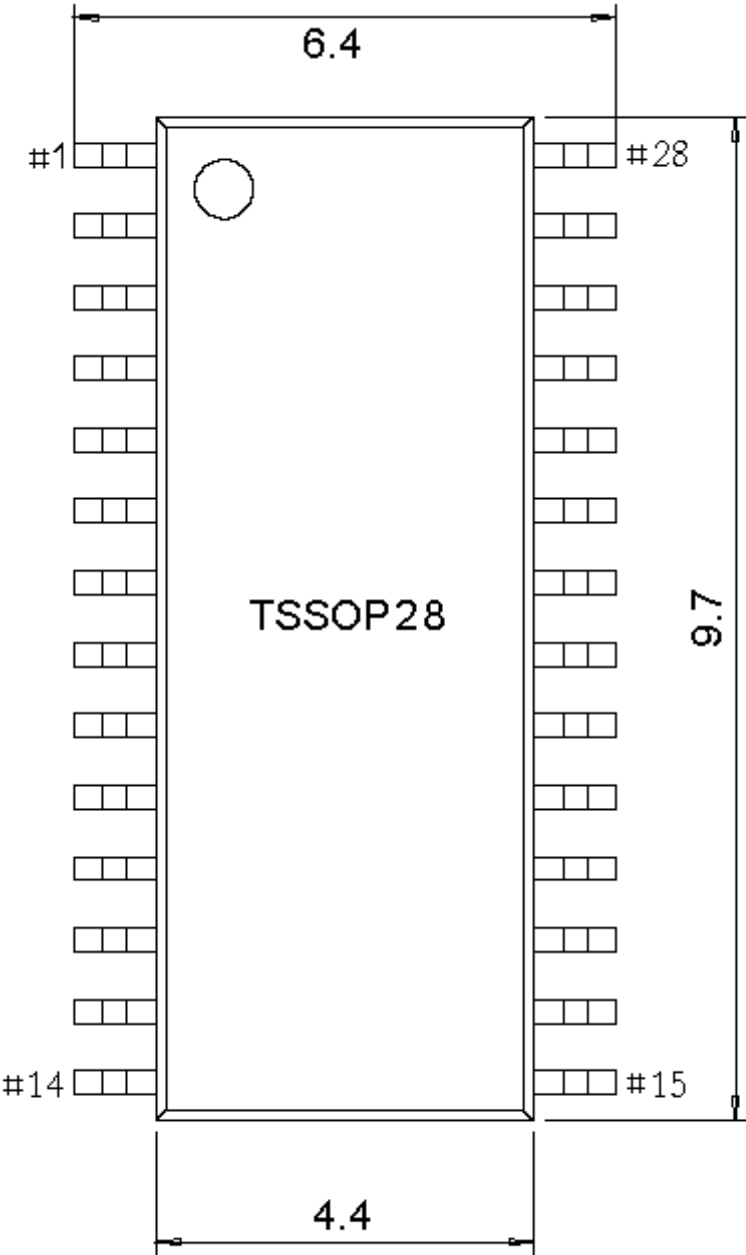

QSOP 类 (3.9mm, 150mil)

QSOP16 (SSOP16-150mil-0.635)

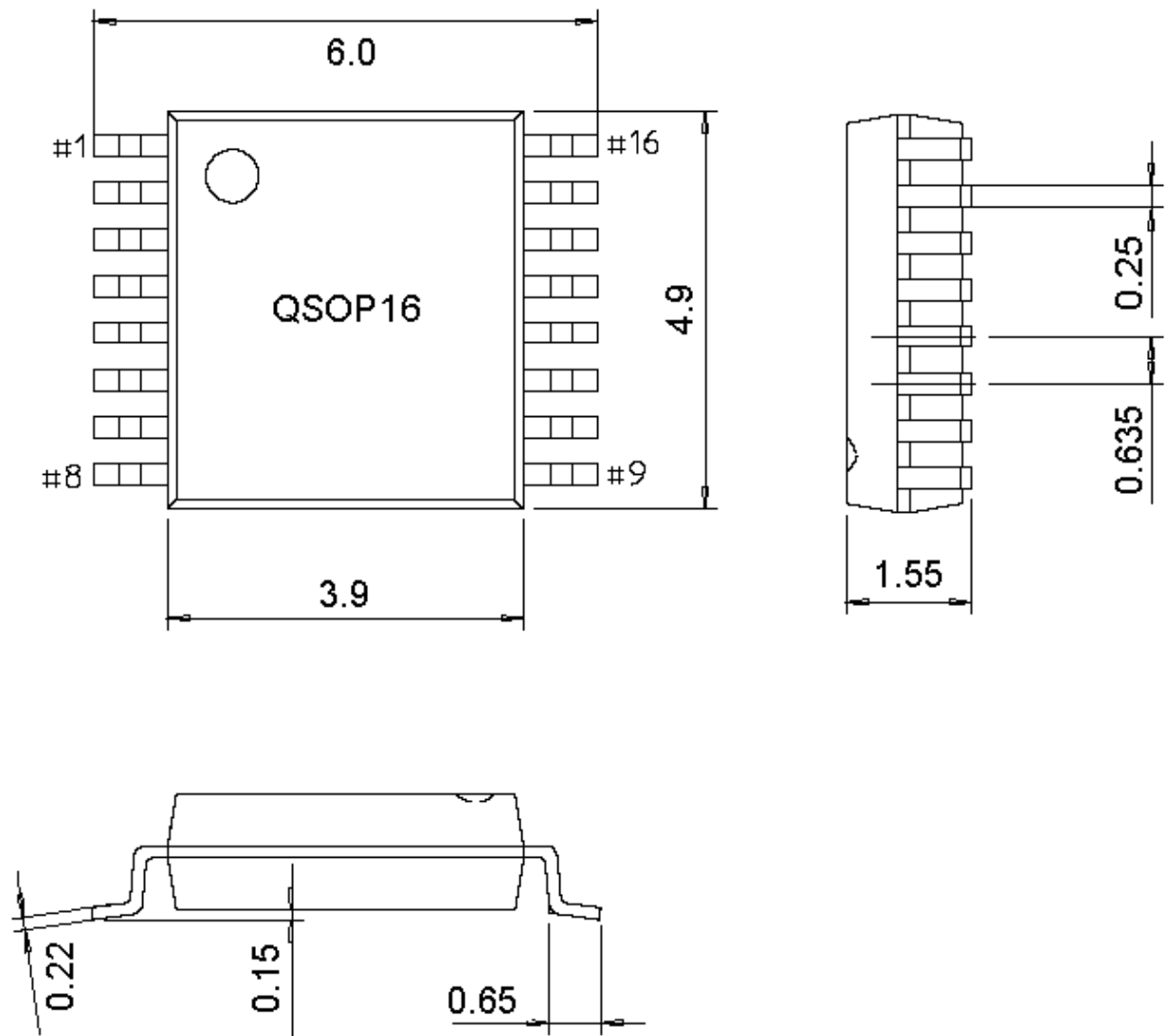

QSOP20 (SSOP20-150mil-0.635)

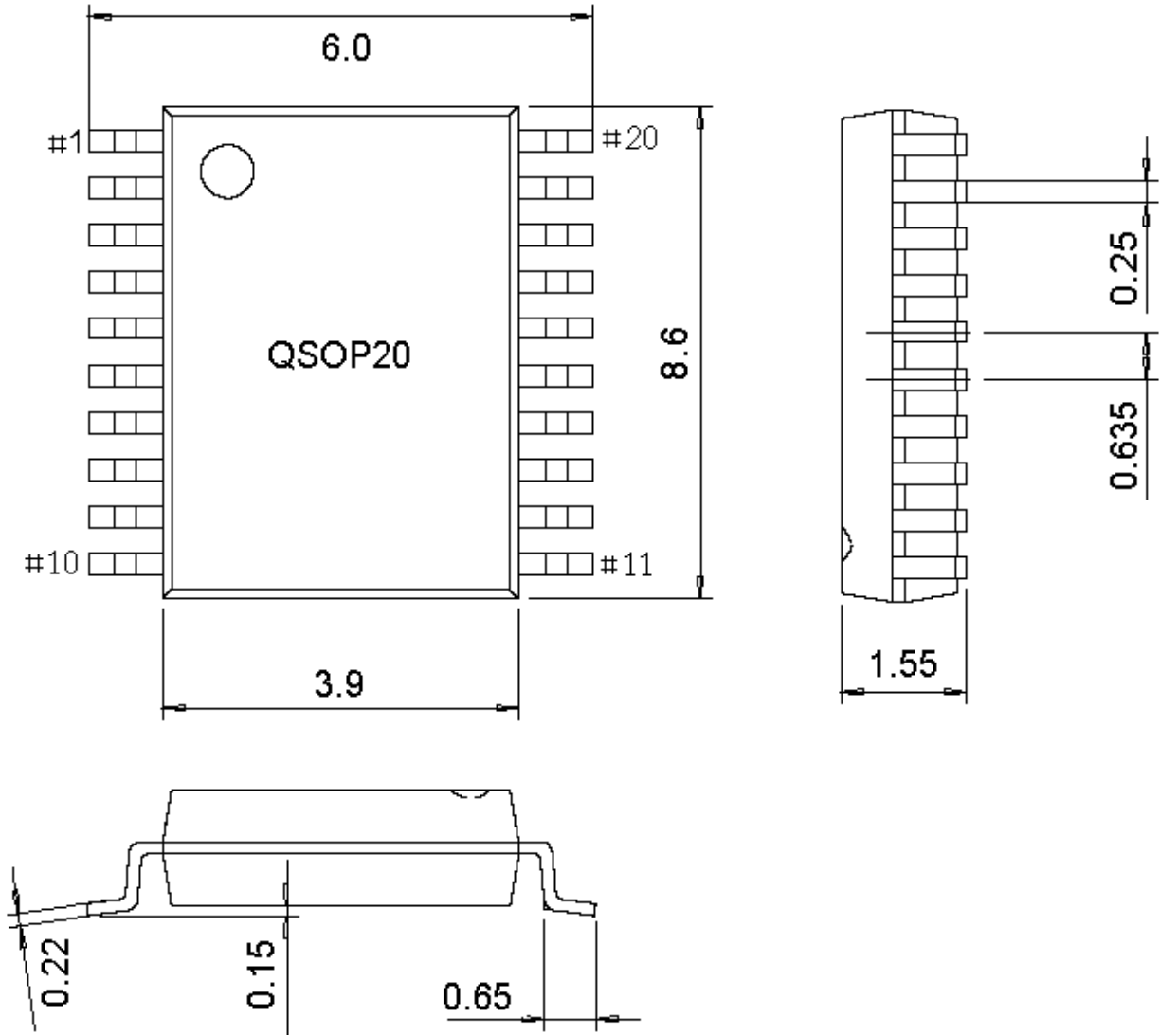

QSOP24 (SSOP24-150mil-0.635)

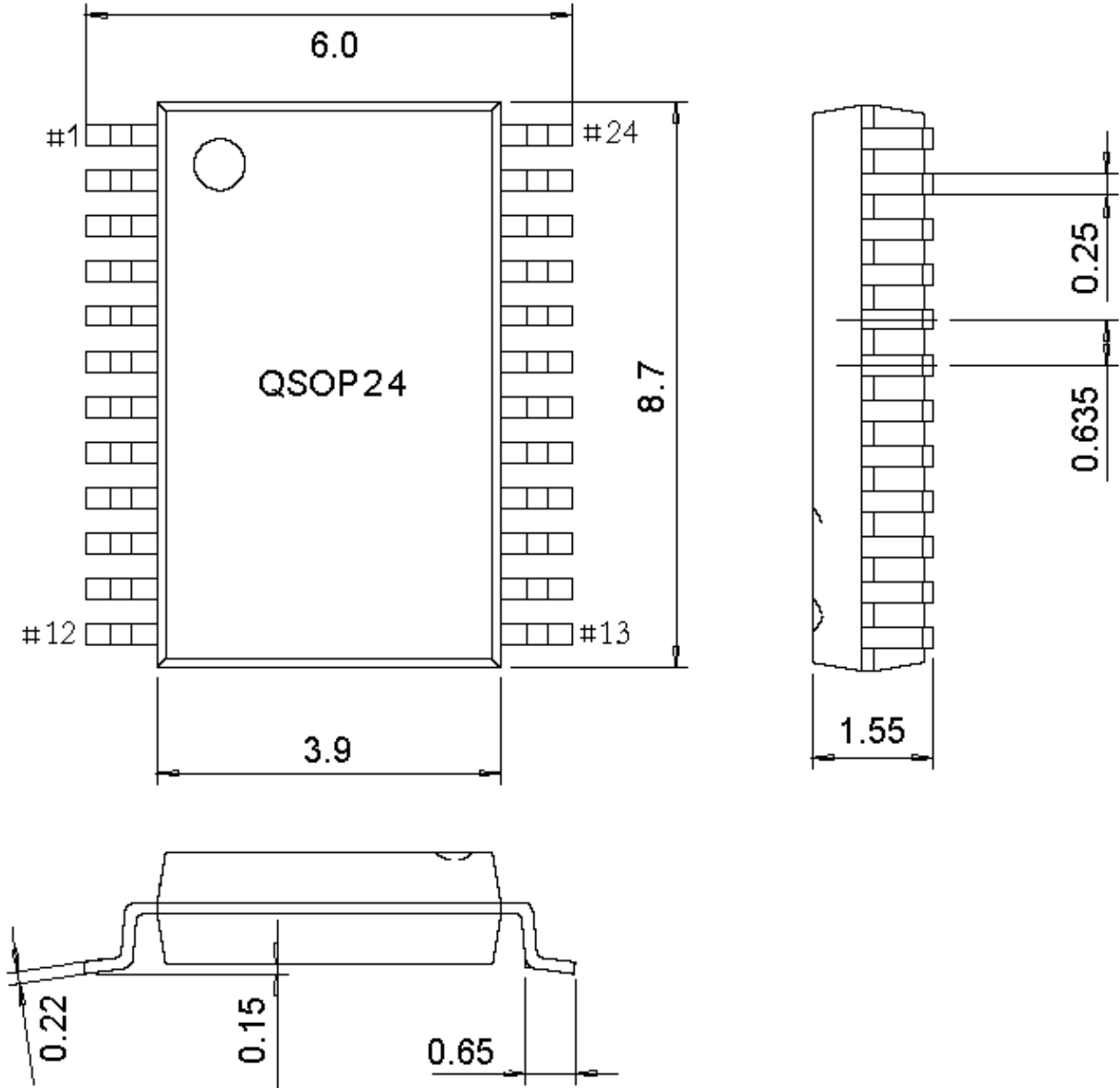

QSOP28 (SSOP28-150mil-0.635)

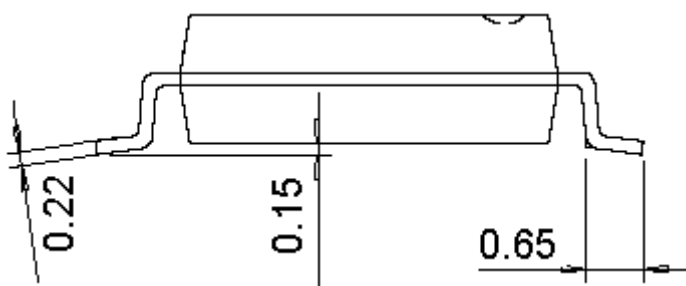
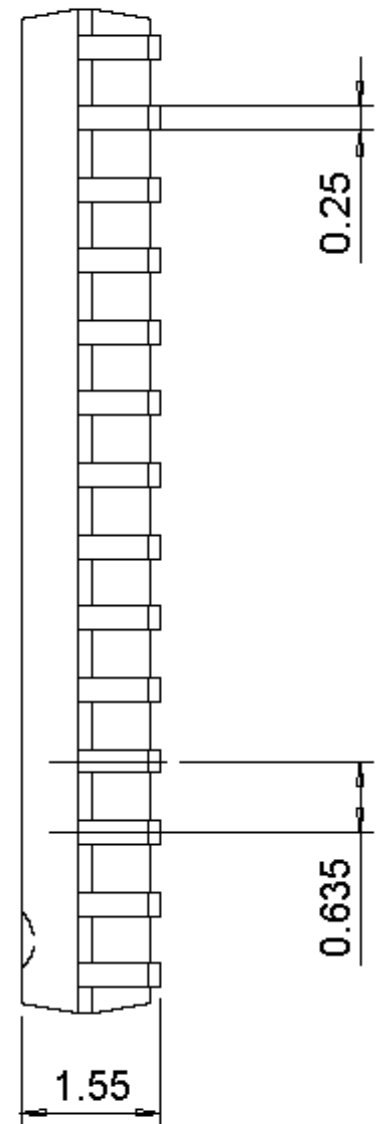
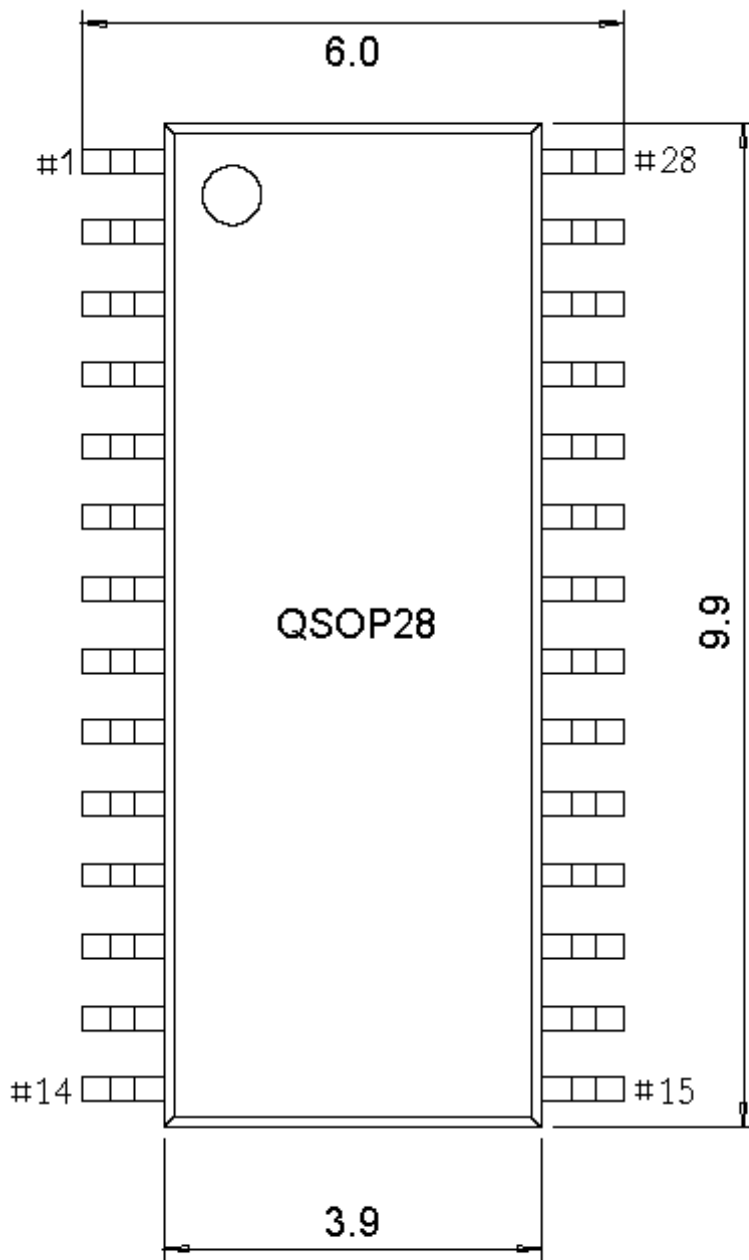

QFP 类 (PQFP、LQFP、TQFP)

PQFP44 (QFP44)

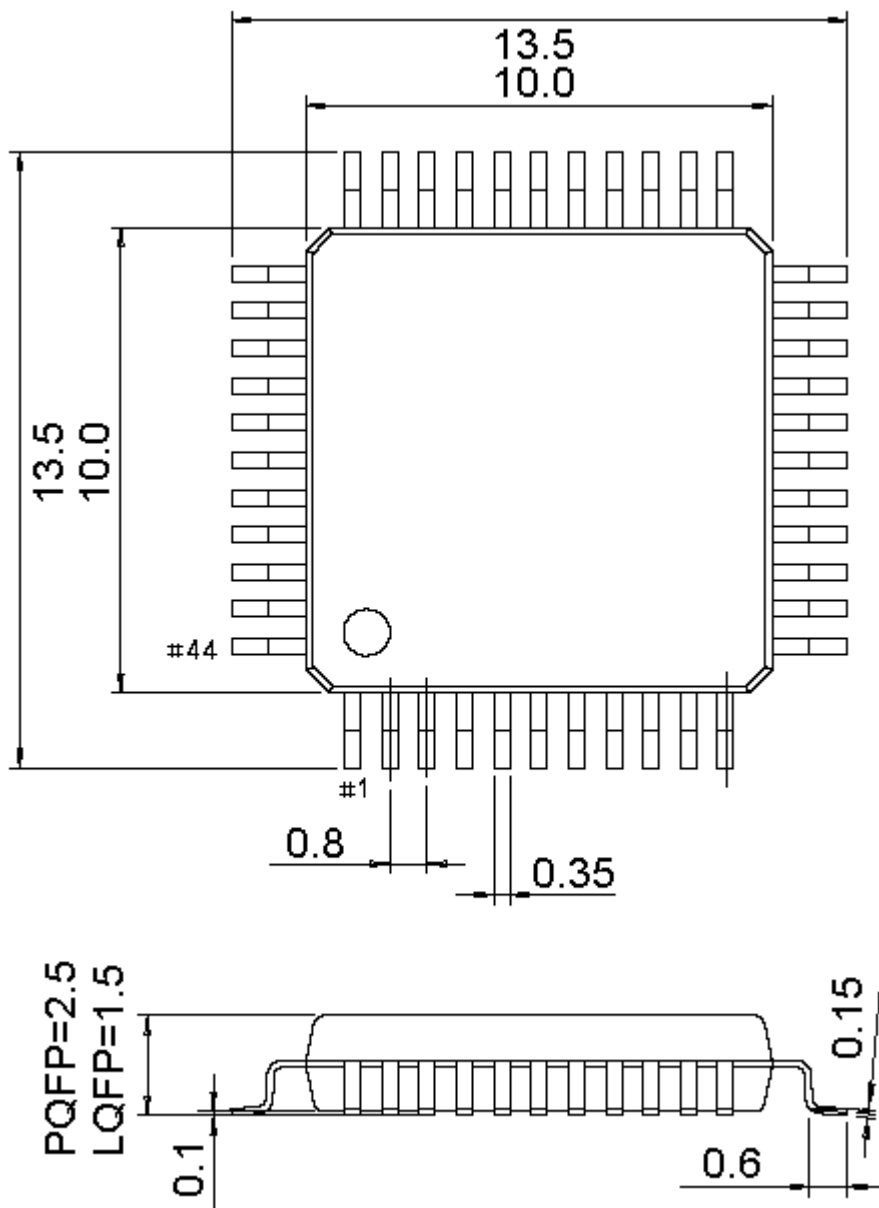

PQFP52 (QFP52)

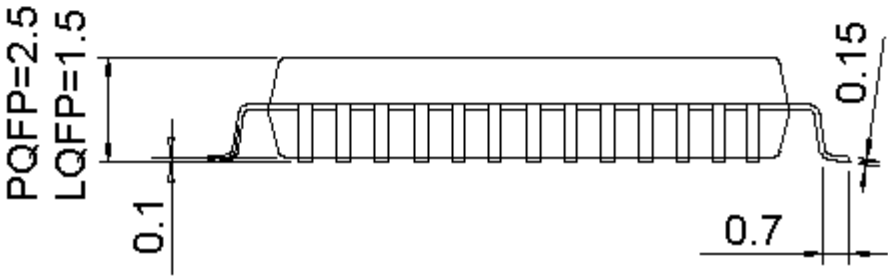
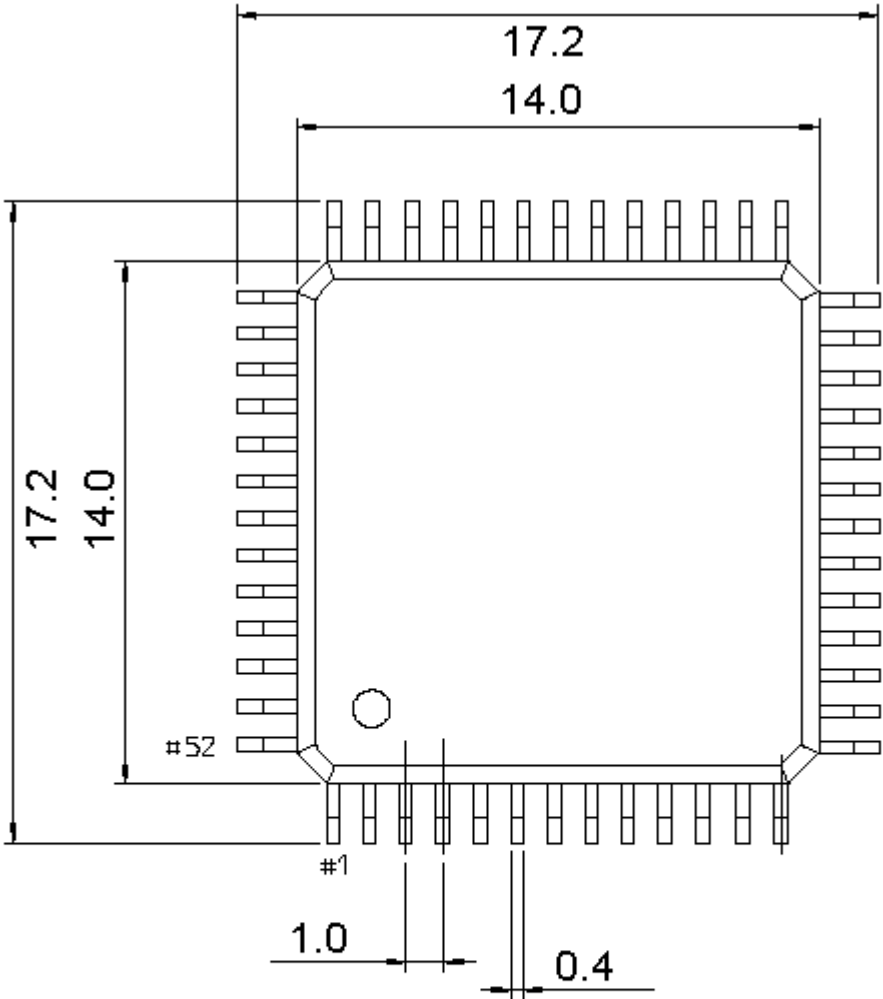

PQFP64 (QFP64)、LQFP64-14*14

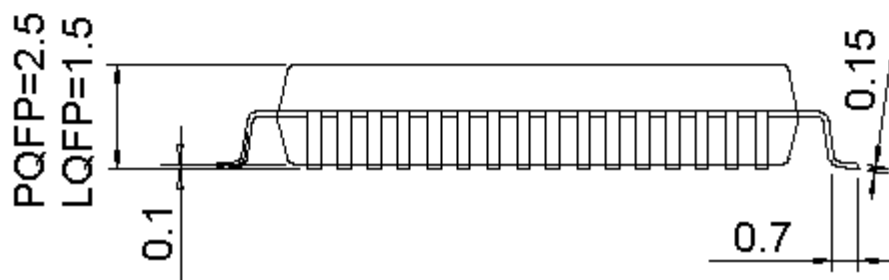
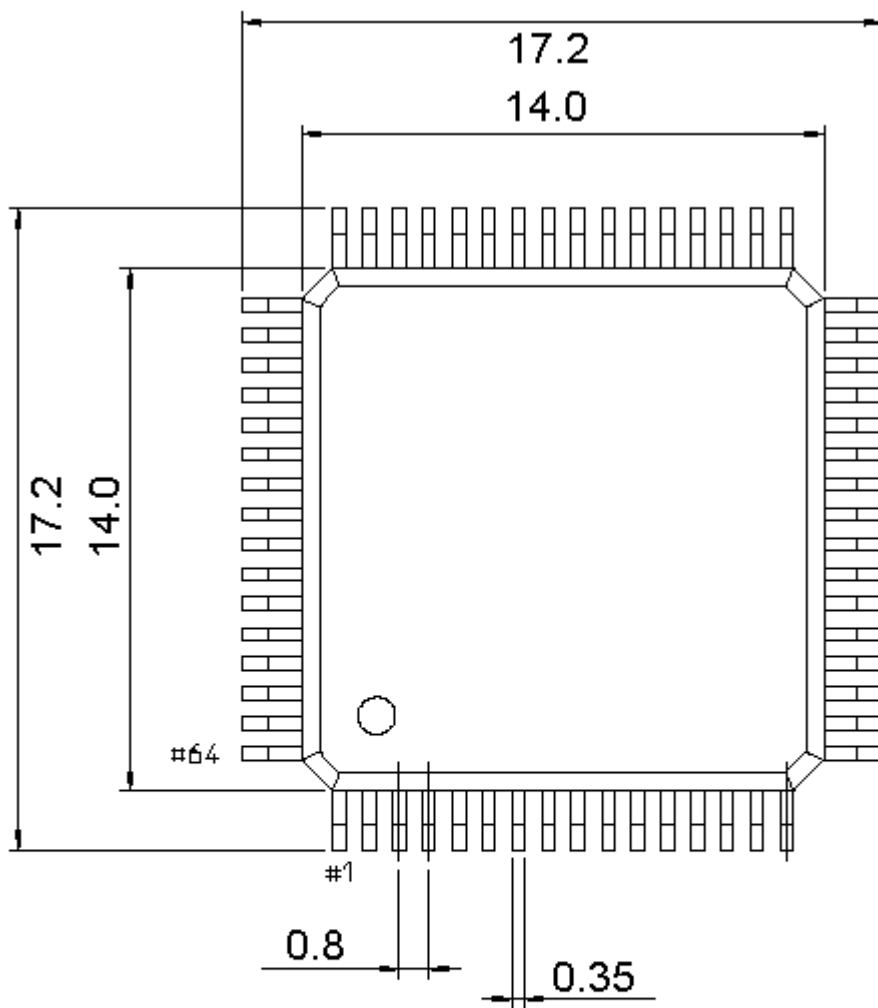

PQFP80 (QFP80)

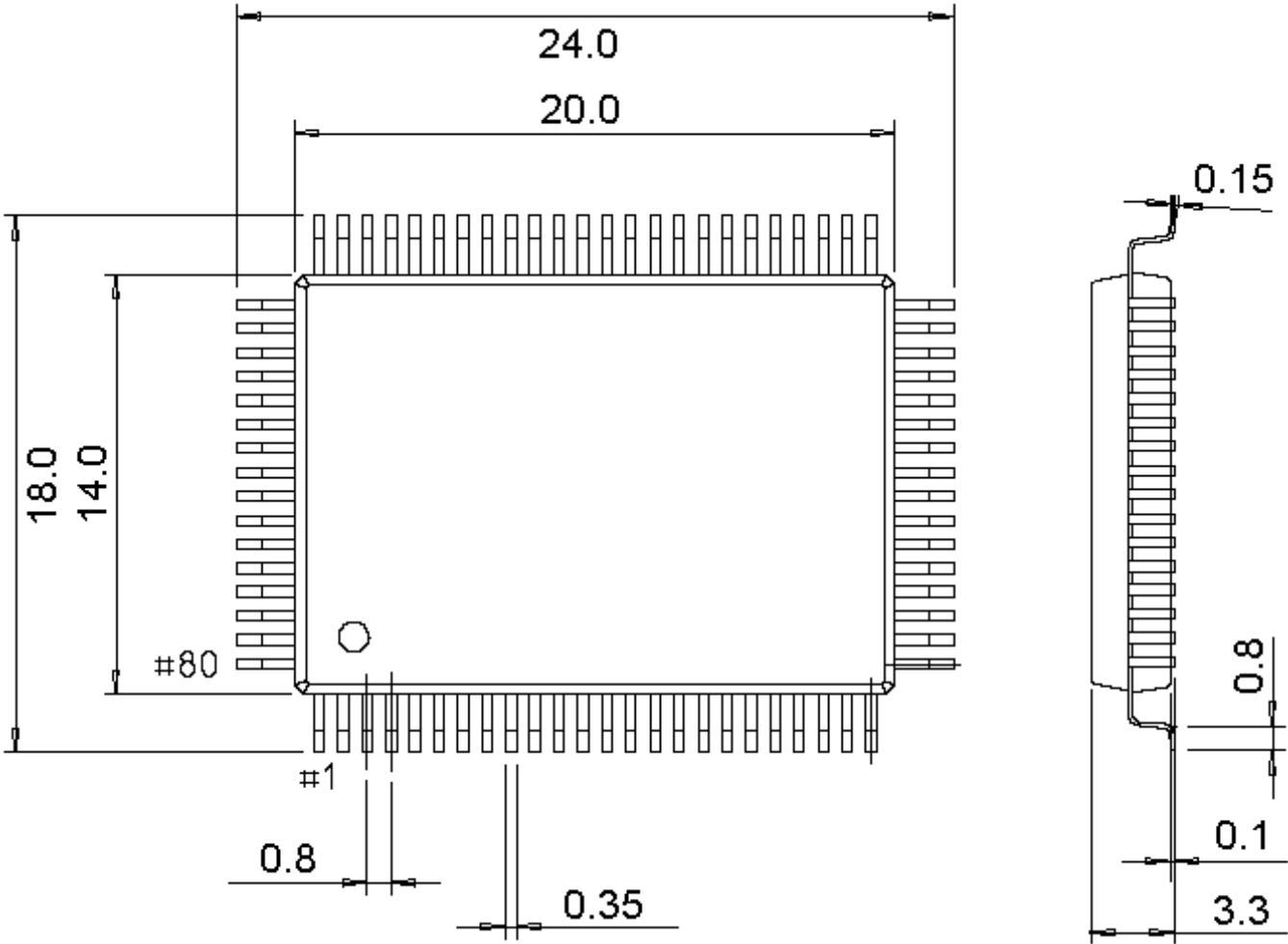

LQFP32 (LQFP32-7*7)

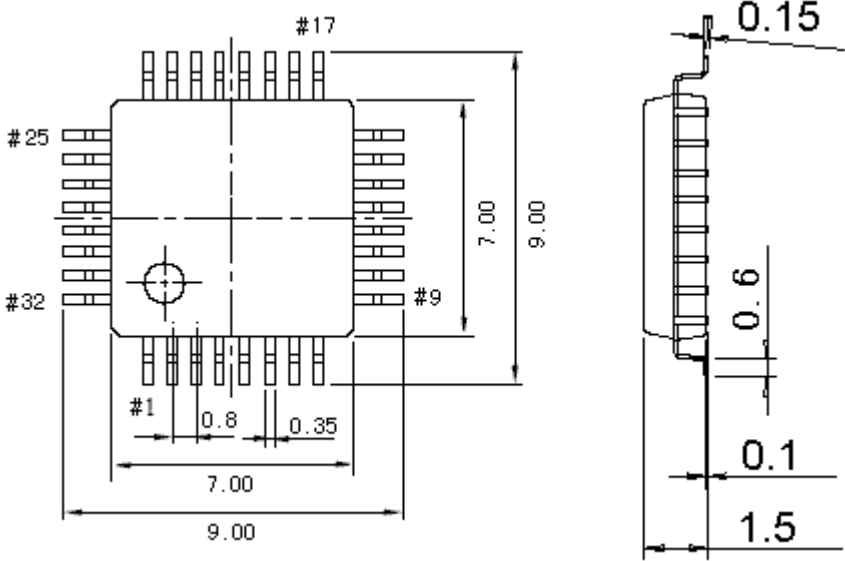

LQFP44 (LQFP44-10*10)

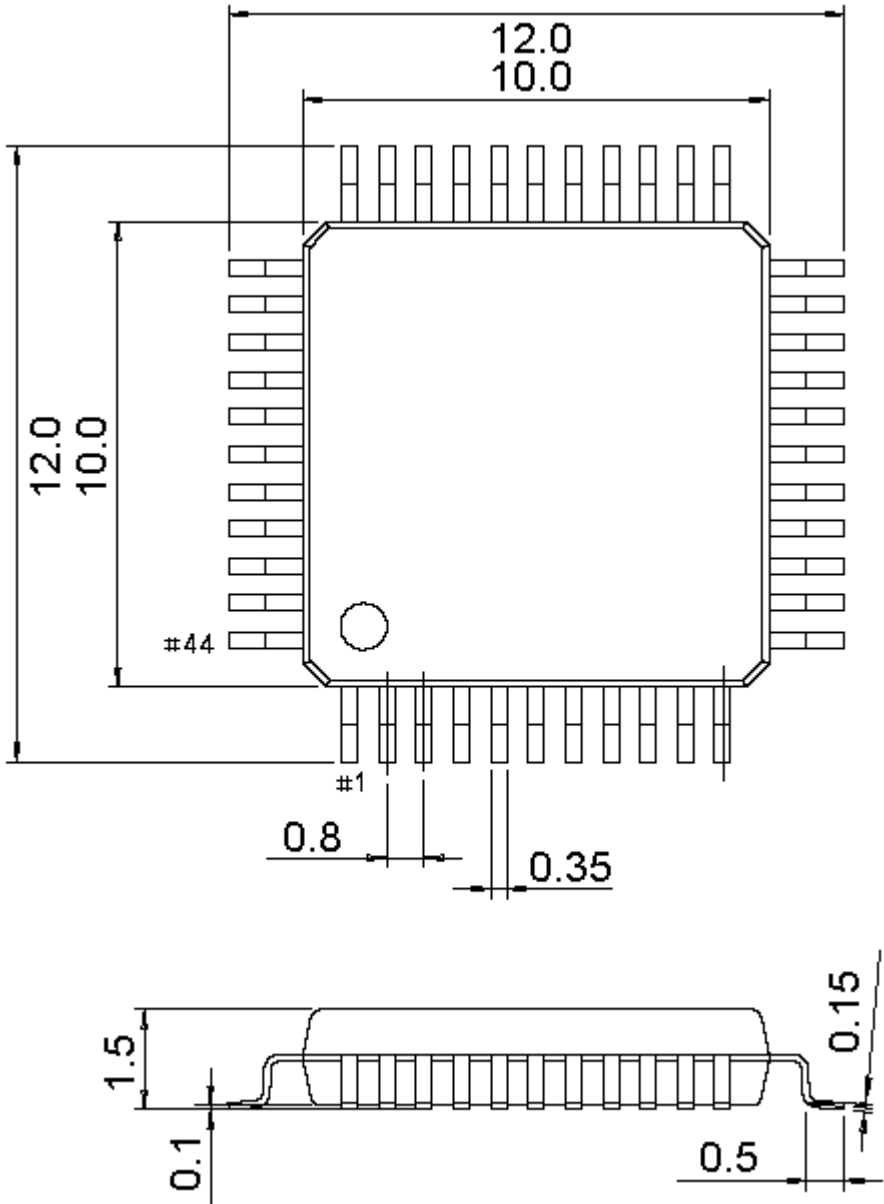

LQFP48 (LQFP48-7*7)、TQFP48、eLQFP48

eLQFP48 Exposed Pad: 3.2*3.2

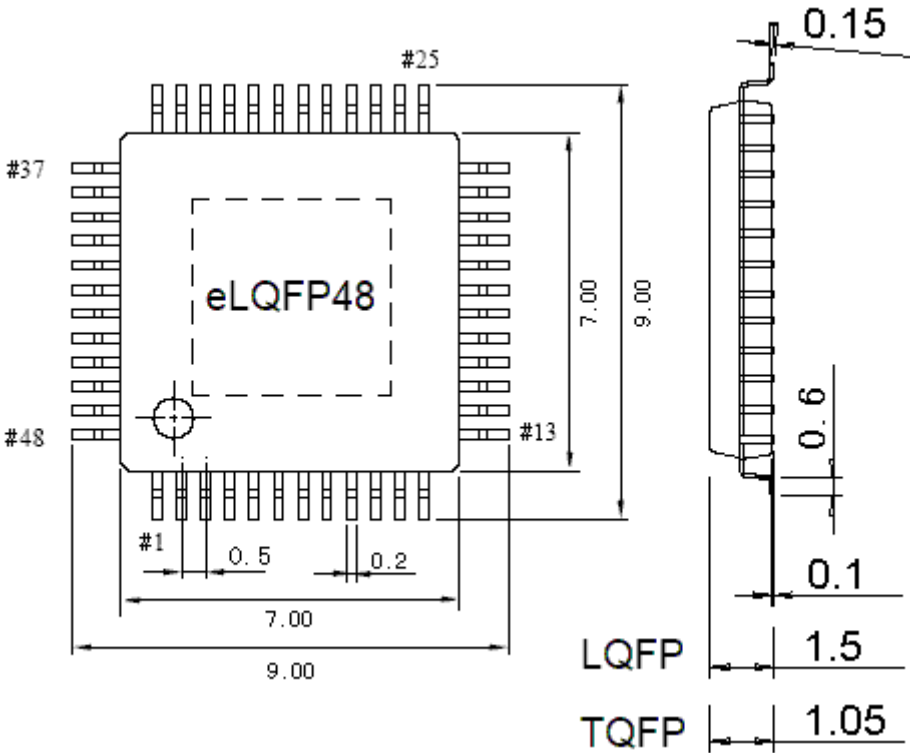

LQFP64 (LQFP64-7*7)、TQFP64、eLQFP64

eLQFP64 Exposed Pad: 3.2*3.2

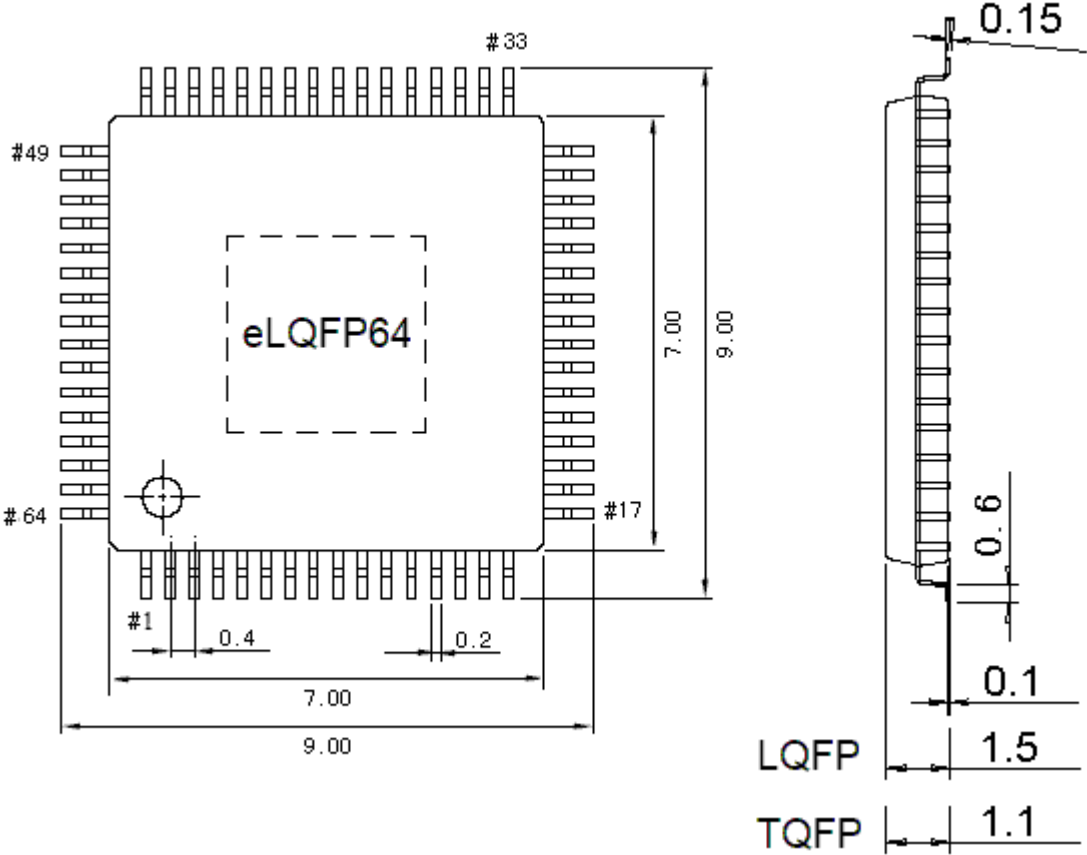

LQFP64M (LQFP64-10*10)

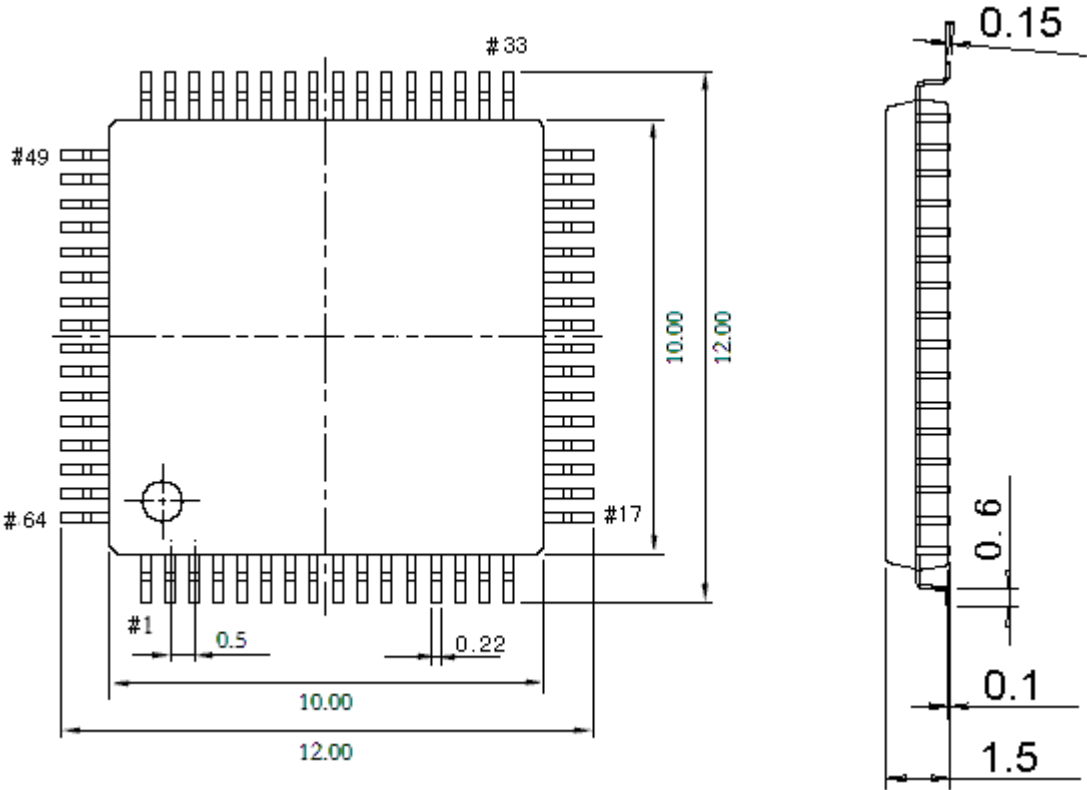

LQFP80 (LQFP80-12*12)

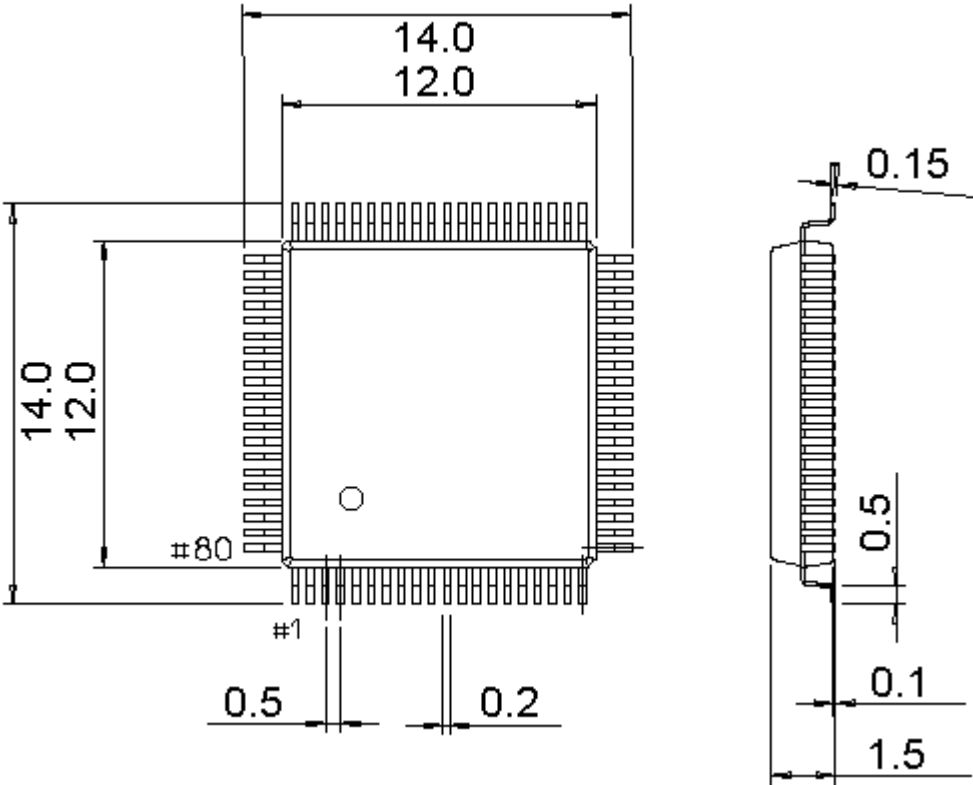

LQFP100 (LQFP100-14*14)

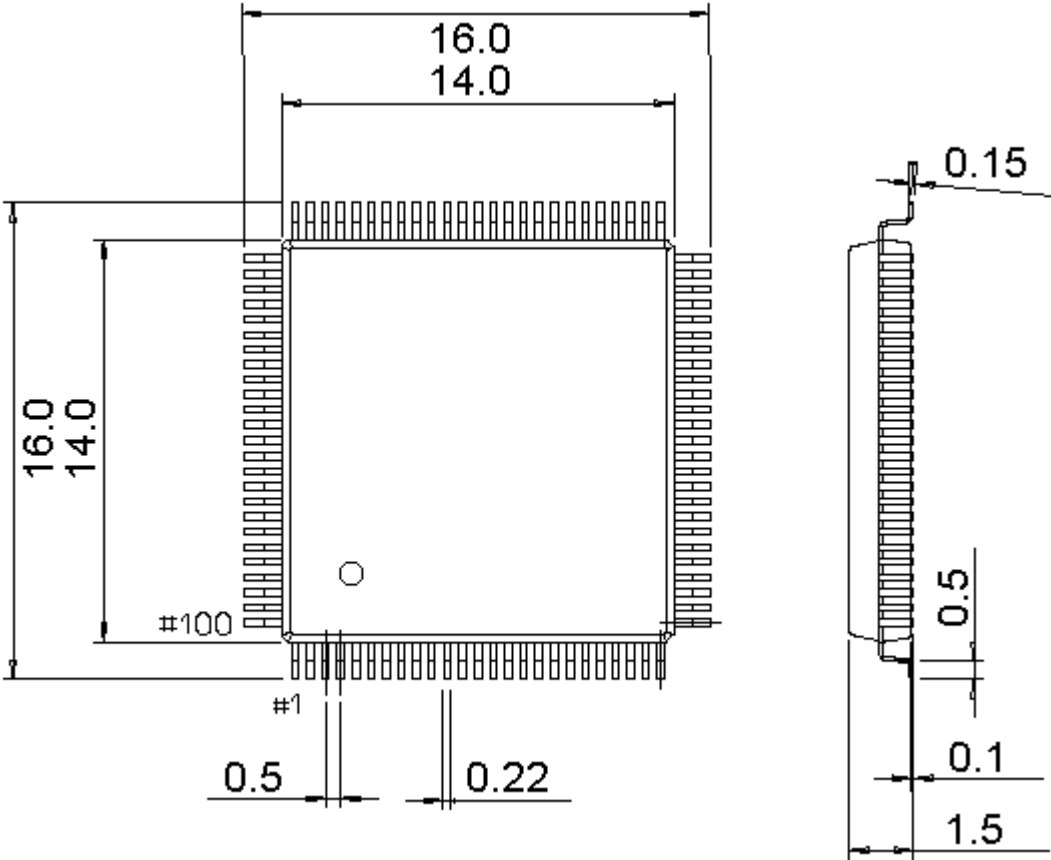

LQFP128 (LQFP128-14*14)

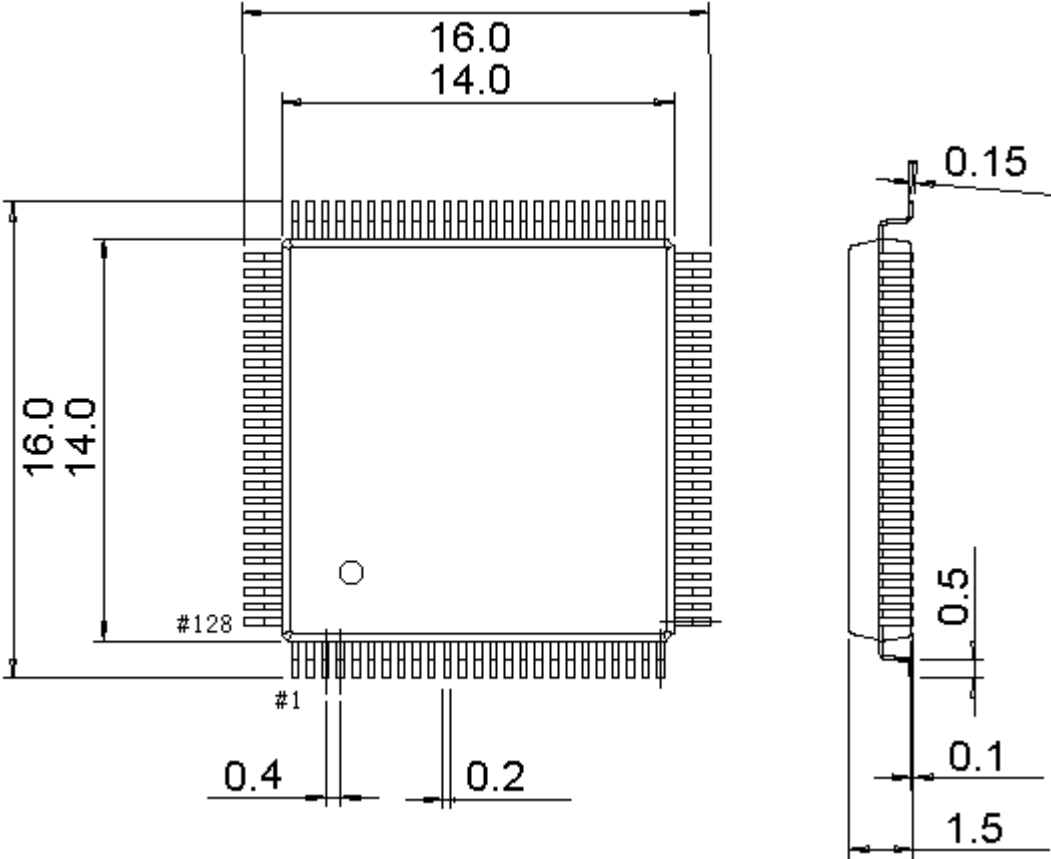

LQFP144 (LQFP144-20*20)

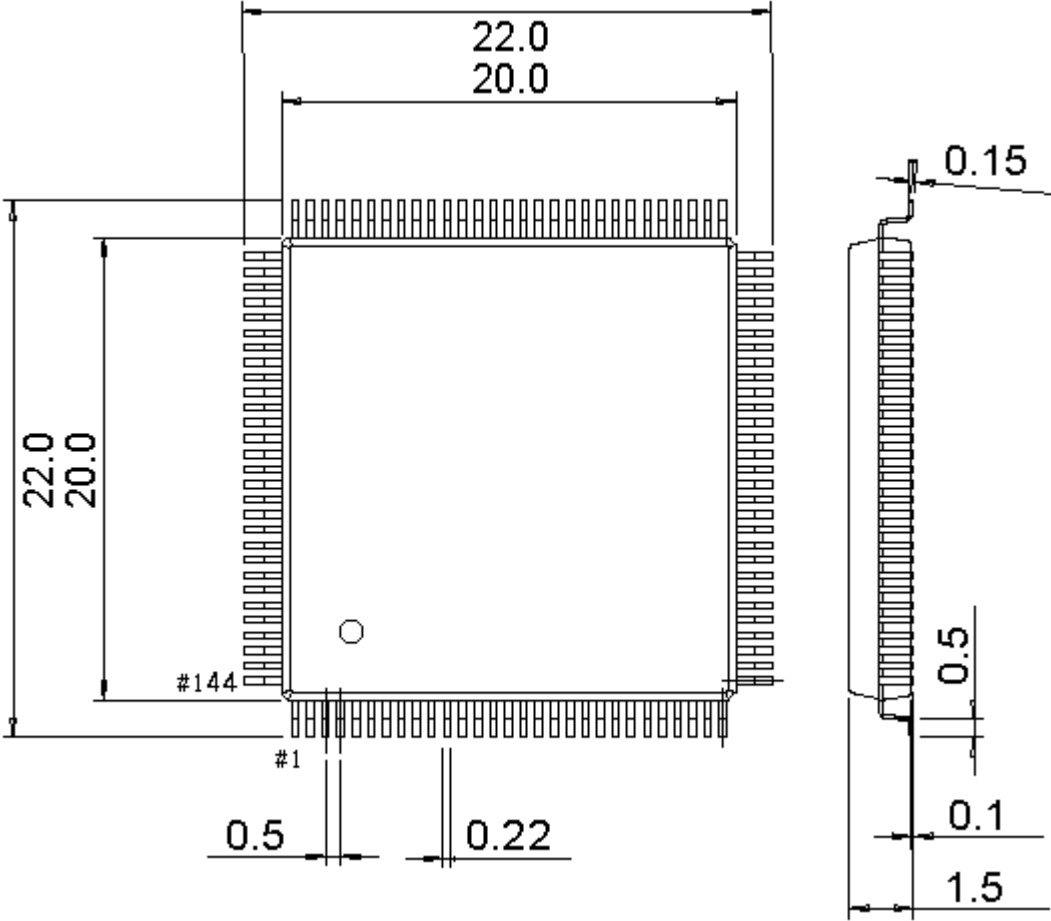

QFN 类

QFN/DFN 命名规则参考

标准命名

QFN ab - d * e * t - p

数字 ab: QFN 封装 4 边累计引脚数。

数字 d 和 e: d 和 e 代表 QFN 外形的长和宽 (1#引脚所在边)。

数字 t: t 代表 QFN 外形的厚度, 常用 0.55 和 0.75 等。

数字 p: p 代表引脚节距 pitch, 即相邻引脚的中心的间距, 如有两种则取其小, 常用 0.4 和 0.5 等。

参考简化命名

QFN ab c d X e

数字 ab: QFN 封装 4 边累计引脚数。

字母 c: 无 c 代表通用 QFN, 有 Exposed Pad, 默认尺寸, 无数字 d 和 e;

字母 X 代表通用 QFN, 有 Exposed Pad, 非默认尺寸, 至少有数字 d;

字母 L 代表通用 QFN, 无 Exposed Pad, 非默认尺寸, 至少有数字 d;

字母 C 代表 WCH 设计的通用 QFN, 有 Exposed Pad, 至少有数字 d;

字母 F 代表 WCH 定制的专用 QFN, 无 Exposed Pad, 至少有数字 d;

字母 E 代表 WCH 定制的专用 QFN, 有 Exposed Pad, 至少有数字 d。

数字 d 和 e: d 和 e 代表 QFN 外形的长和宽 (1#引脚所在边);

无 d 无 e 代表默认尺寸, 也是常用尺寸;

有 d 无 e 代表尺寸为 d*d 正方形;

如果数字超过 13 则需除以 10, 例如 45 表示 4.5。

默认尺寸通常是指 pitch=0.4 时的最小正方形尺寸, 也是常用尺寸:

QFN12、QFN14 默认为 2*2 正方形;

QFN16、QFN20 默认为 3*3 正方形;

QFN24、QFN28、QFN32 默认为 4*4 正方形;

QFN36、QFN40、QFN44 默认为 5*5 正方形。

以 QFN20 为例:

QFN20: 通用 QFN, 有 Exposed Pad, 默认尺寸 (QFN20 默认为 3*3);

QFN20X4: 通用 QFN, 有 Exposed Pad, 尺寸为 4*4;

QFN20X25X45: 通用 QFN, 有 Exposed Pad, 尺寸为 2.5*4.5;

QFN20C2: WCH 设计的通用 QFN, 有 Exposed Pad, 尺寸为 2*2;

QFN20F3: WCH 定制的专用 QFN, 无 Exposed Pad, 尺寸为 3*3;

QFN20E3X4: WCH 定制的专用 QFN, 有 Exposed Pad, 尺寸为 3*4。

QFN10L14X18 (QFN10-1.4*1.8*0.55-0.4)

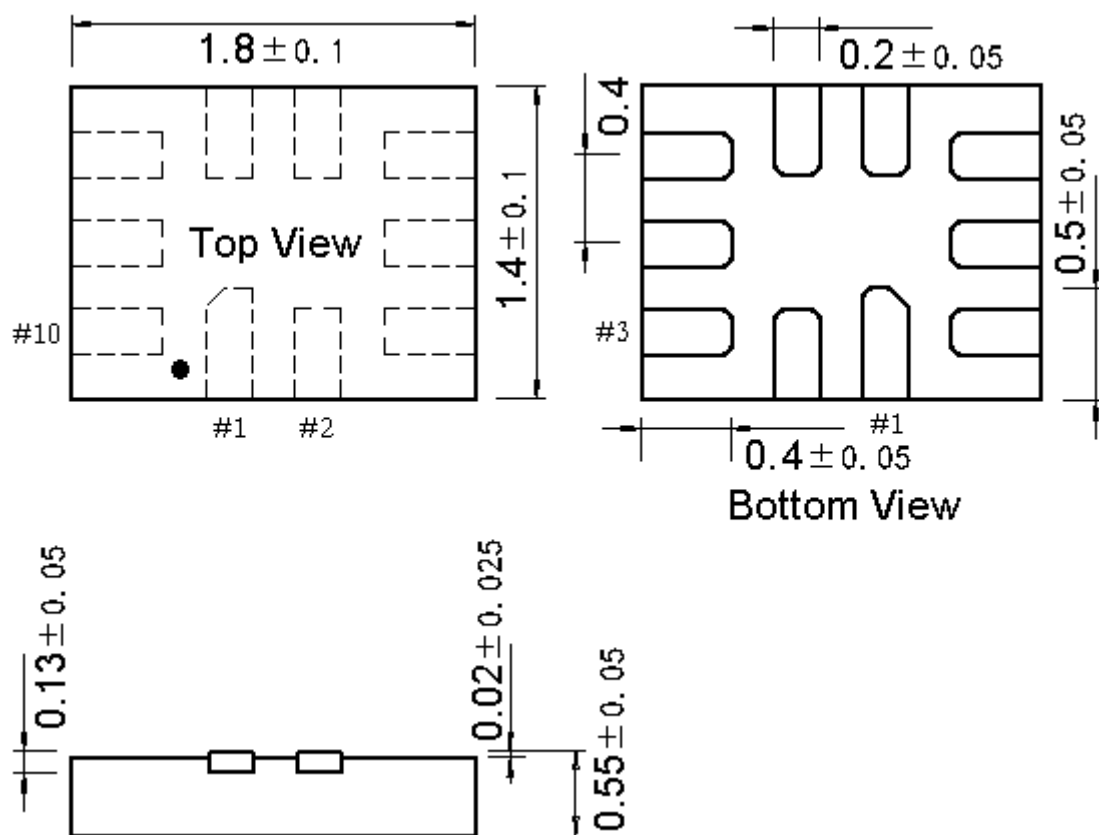

QFN10L15X2 (QFN10-1.5*2*0.55-0.4)

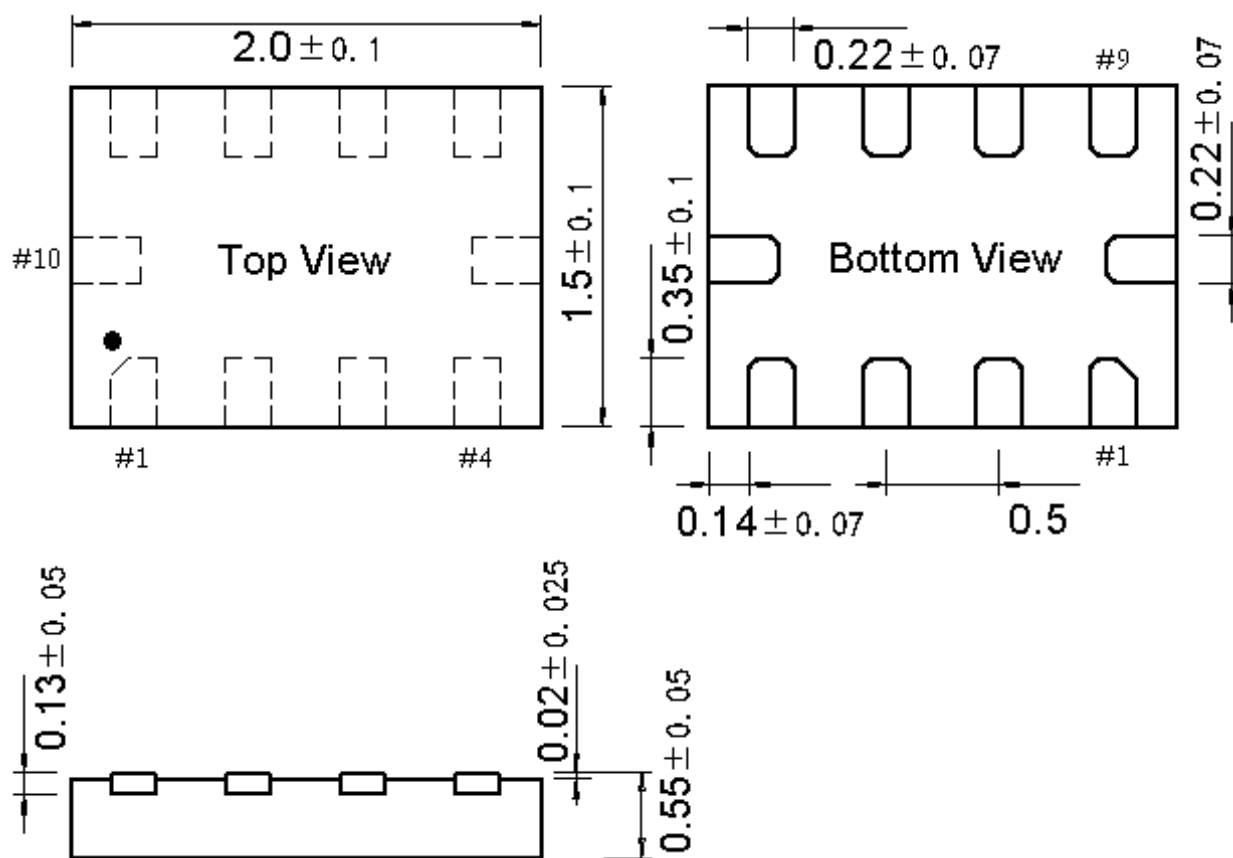

QFN12 (QFN12-2*2*0.5-0.4)

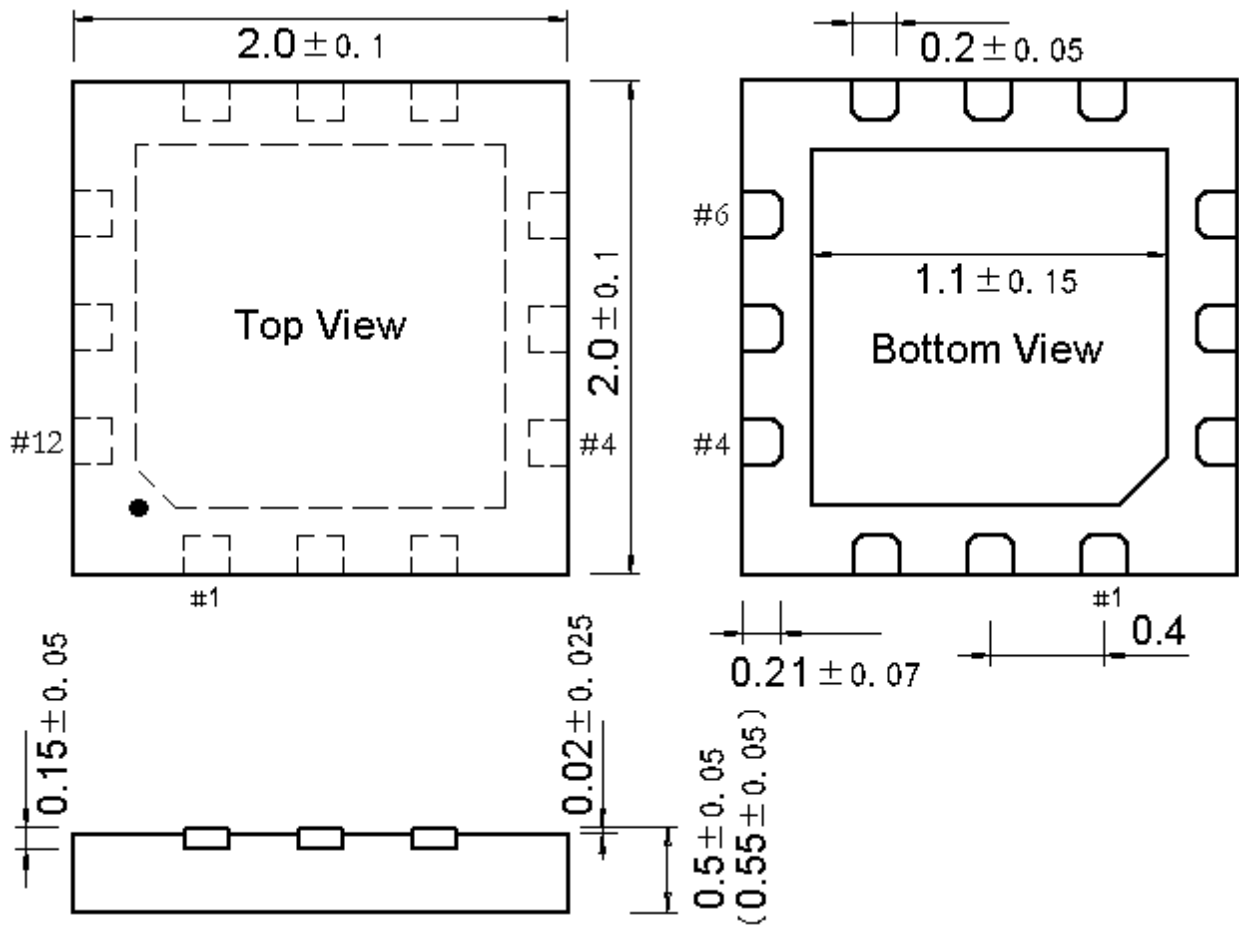

QFN14X25 (QFN14-2.5*2.5*0.75-0.5)

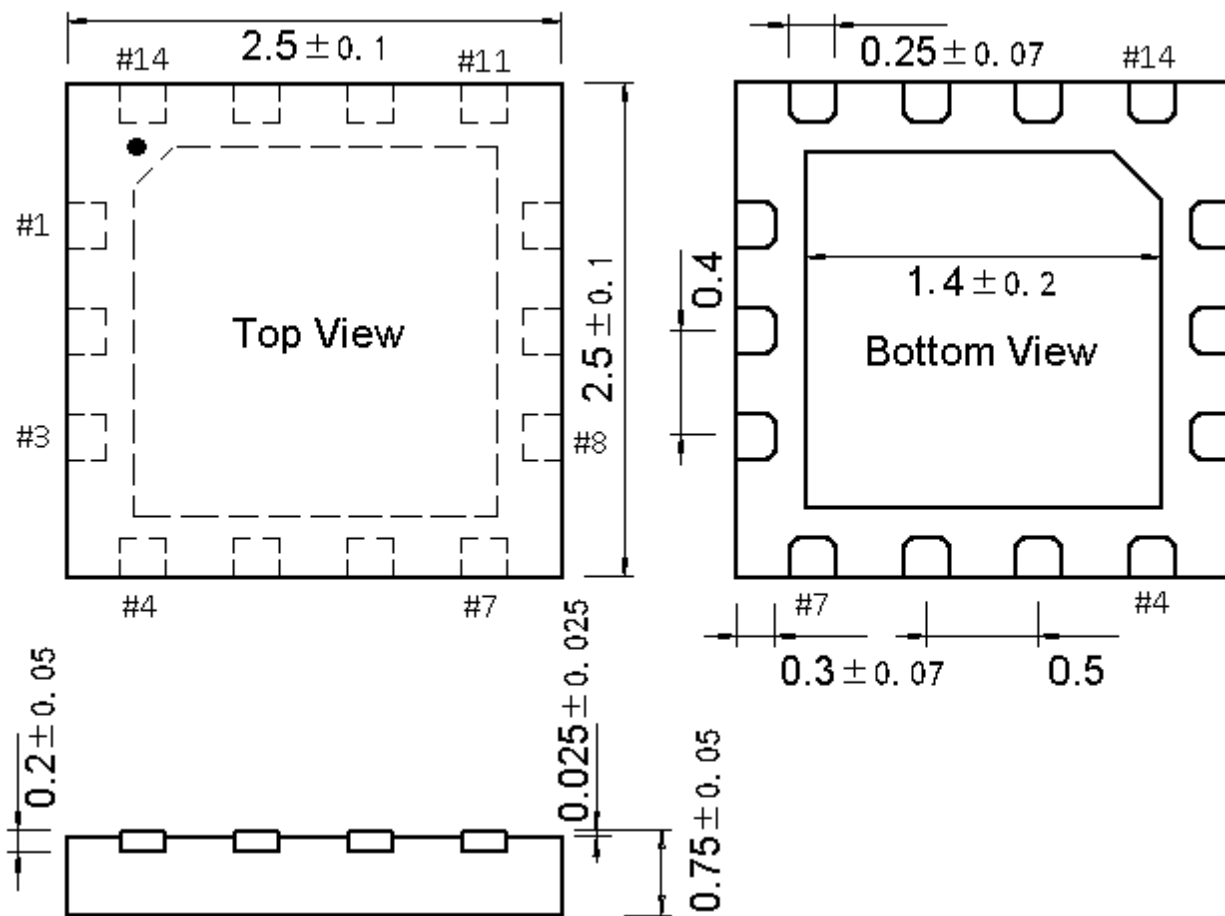

QFN16C2 (QFN16C-2*2*0.55-0.4)

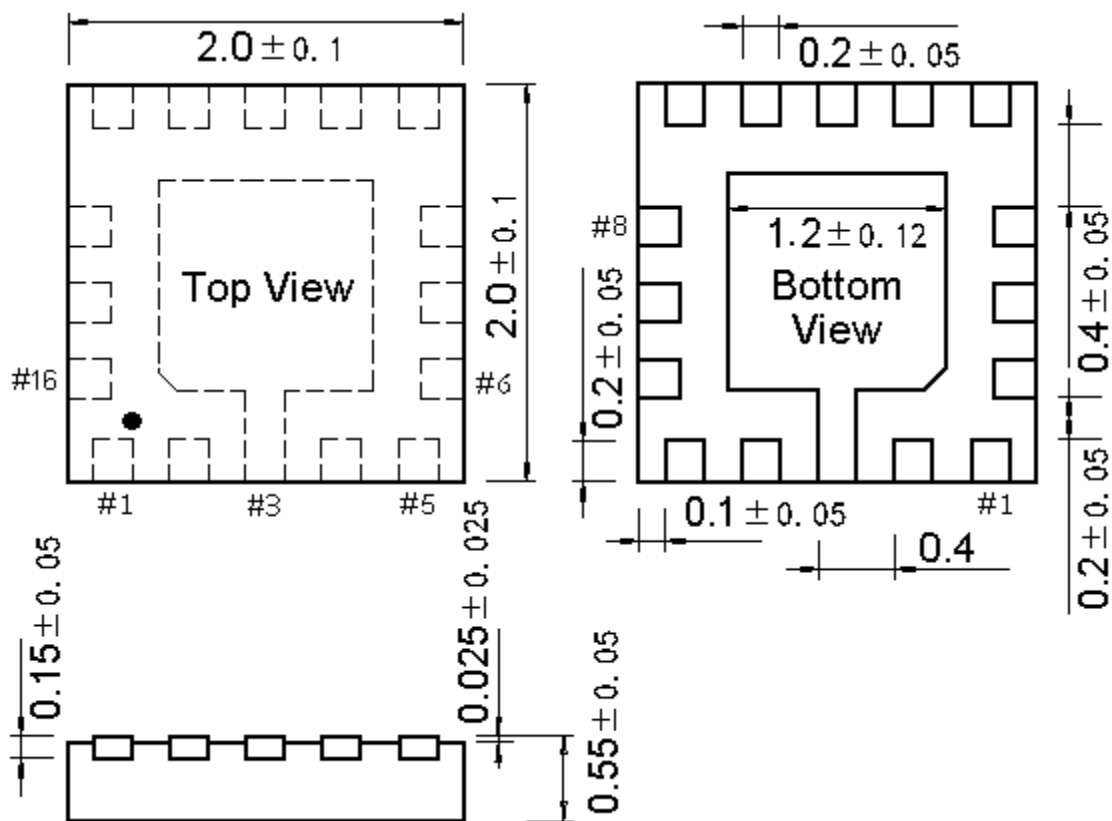

QFN16 (QFN16-3*3)

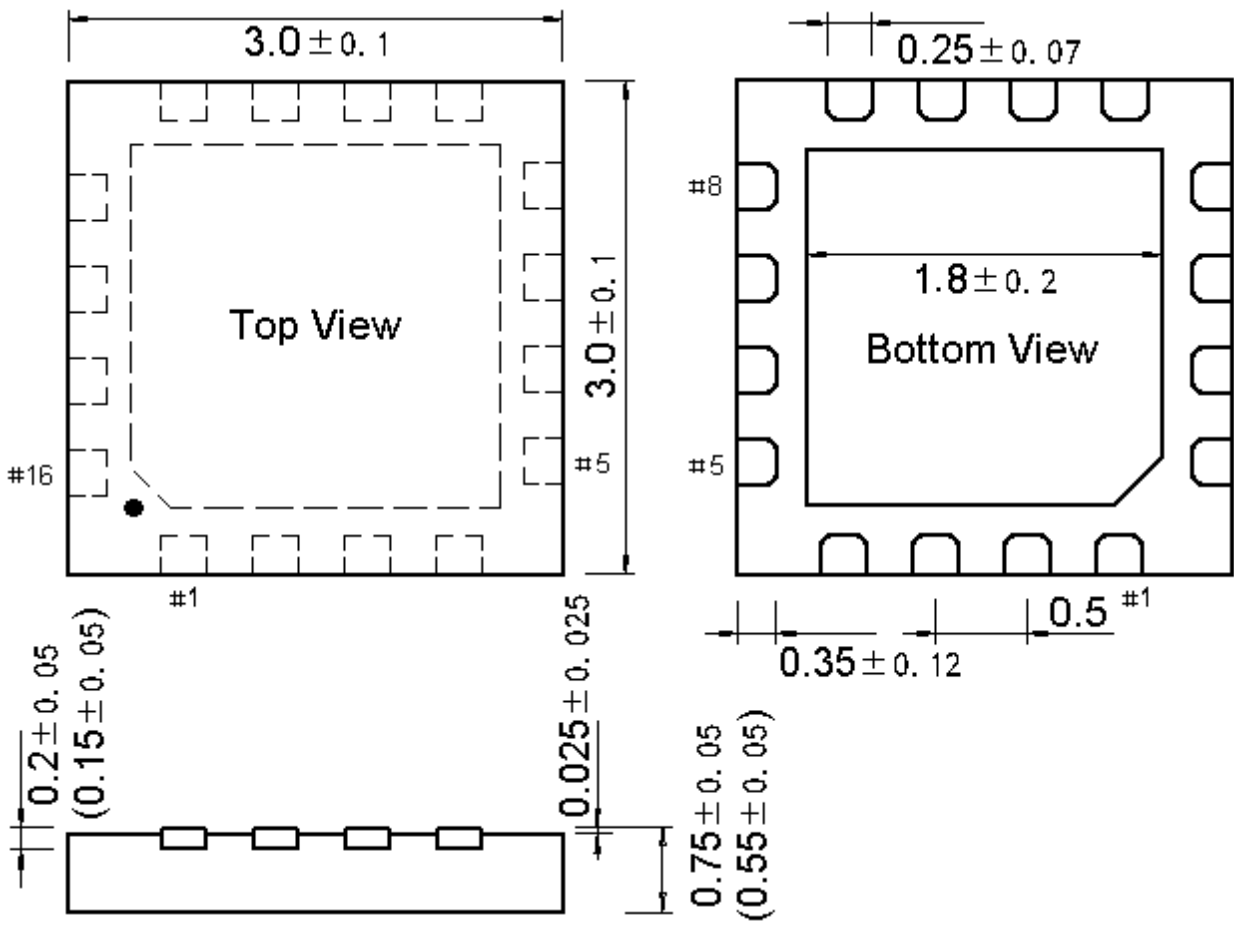

QFN16X4 (QFN16-4*4)

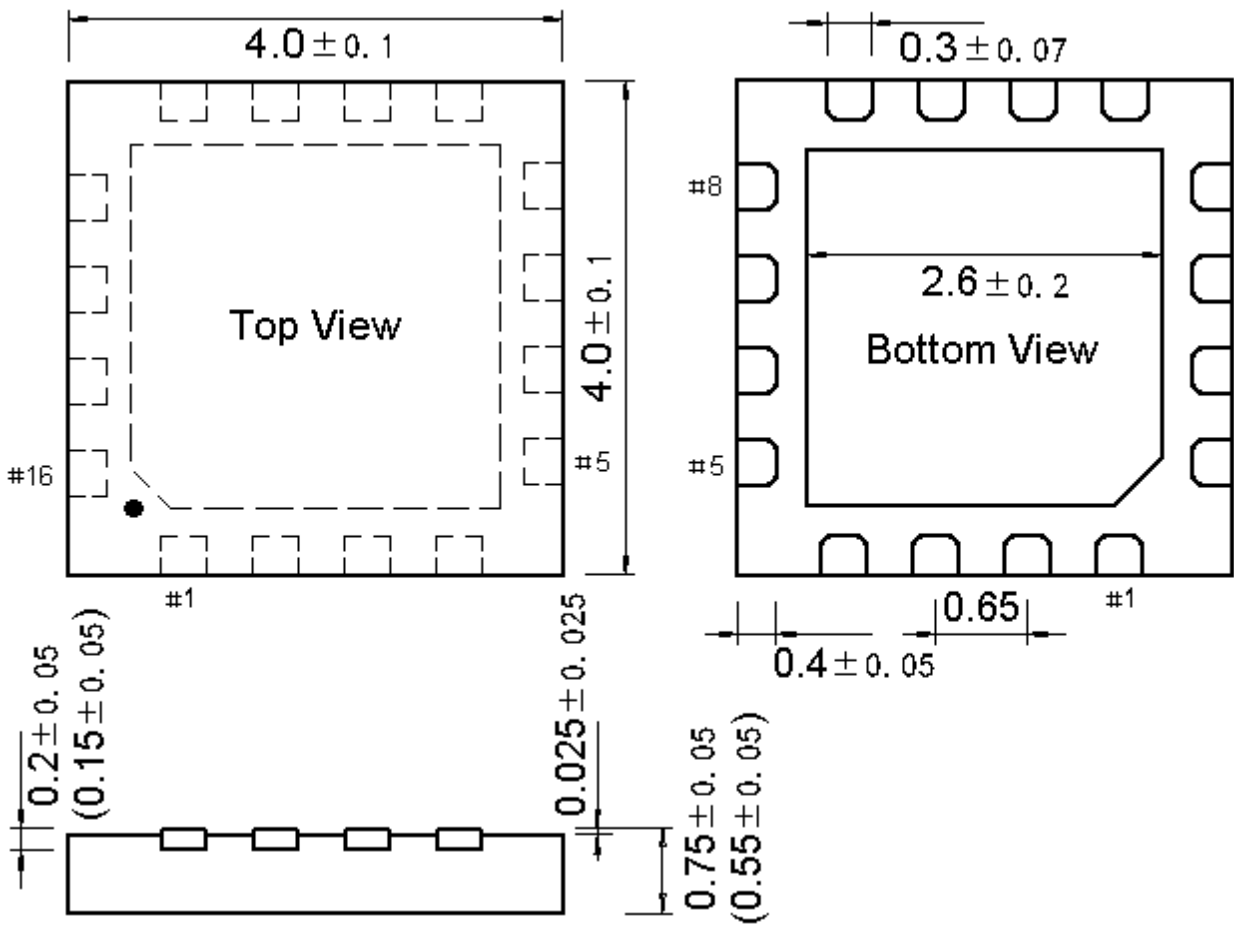

QFN20 (QFN20-3*3)

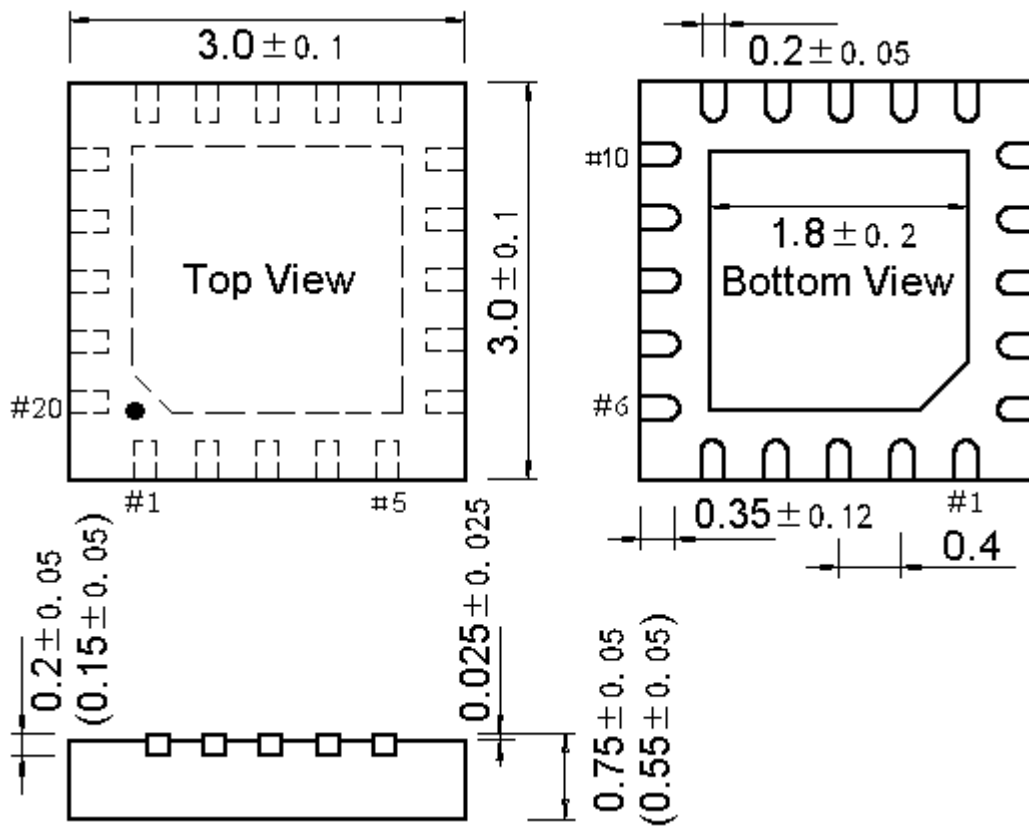

QFN20X4 (QFN20-4*4)

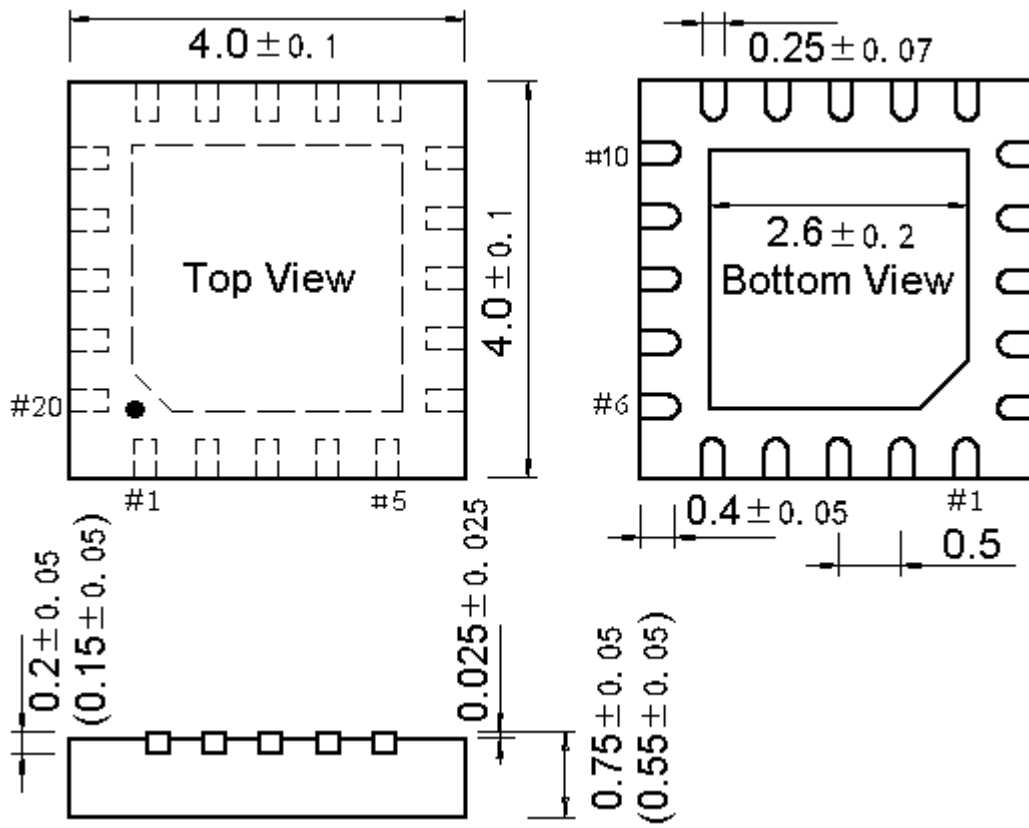

QFN20X25X45 (QFN20-2.5*4.5*0.75-0.5)

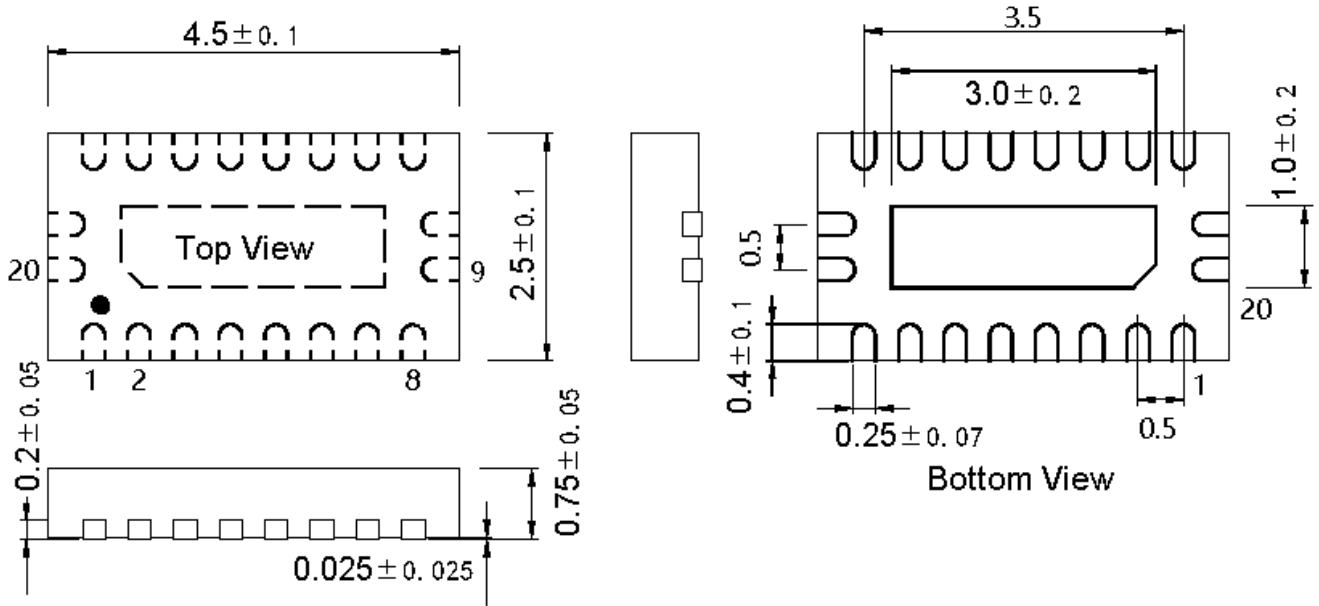

QFN20C2 (QFN20C-2*2*0.55-0.32)

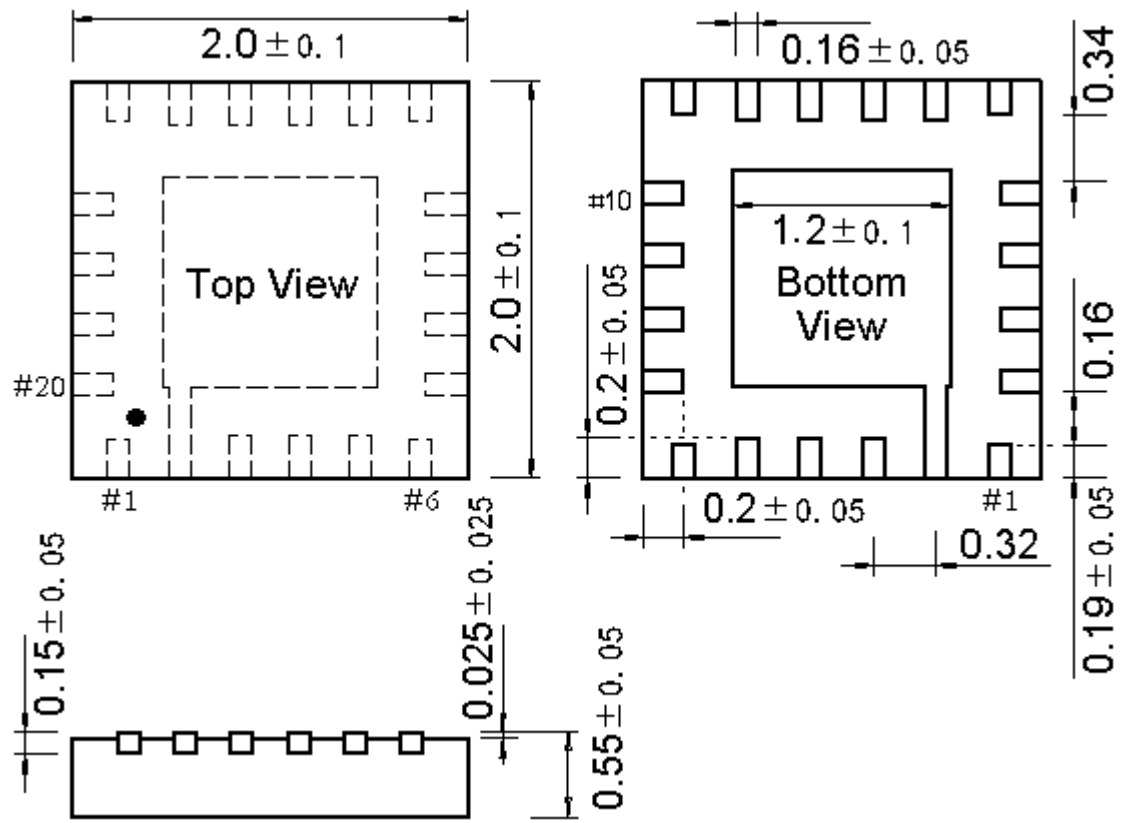

QFN24 (QFN24-4*4)

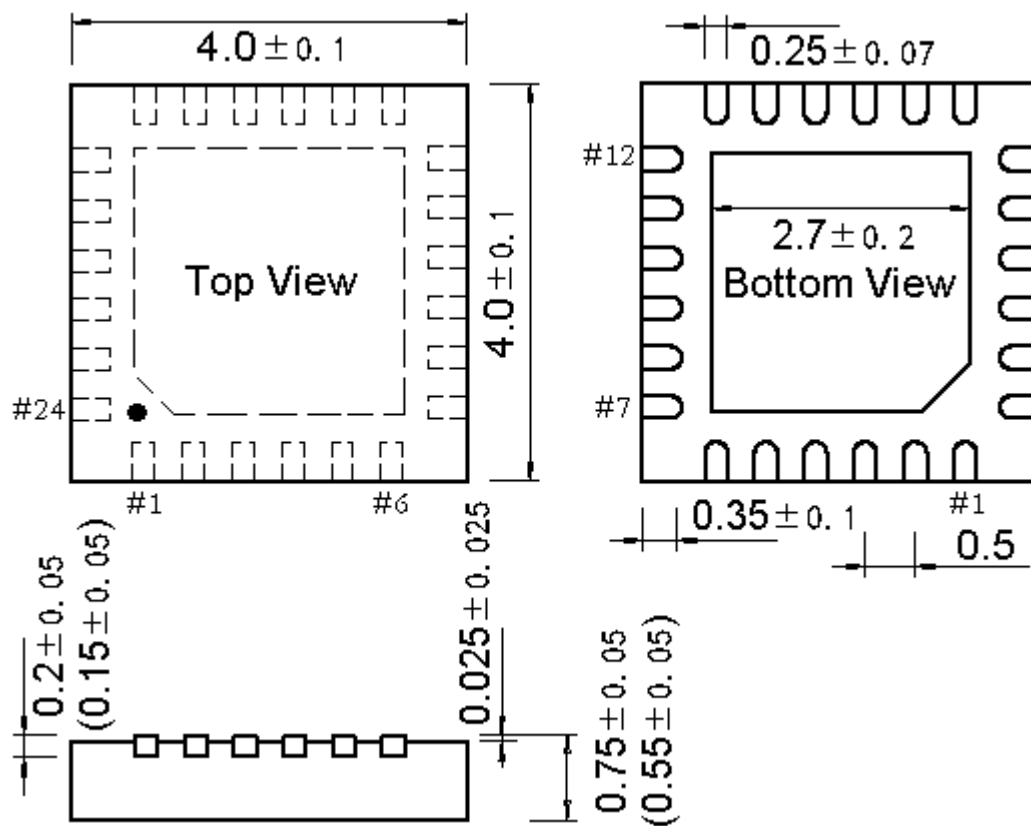

QFN24X3 (QFN24-3*3*0.55-0.4)

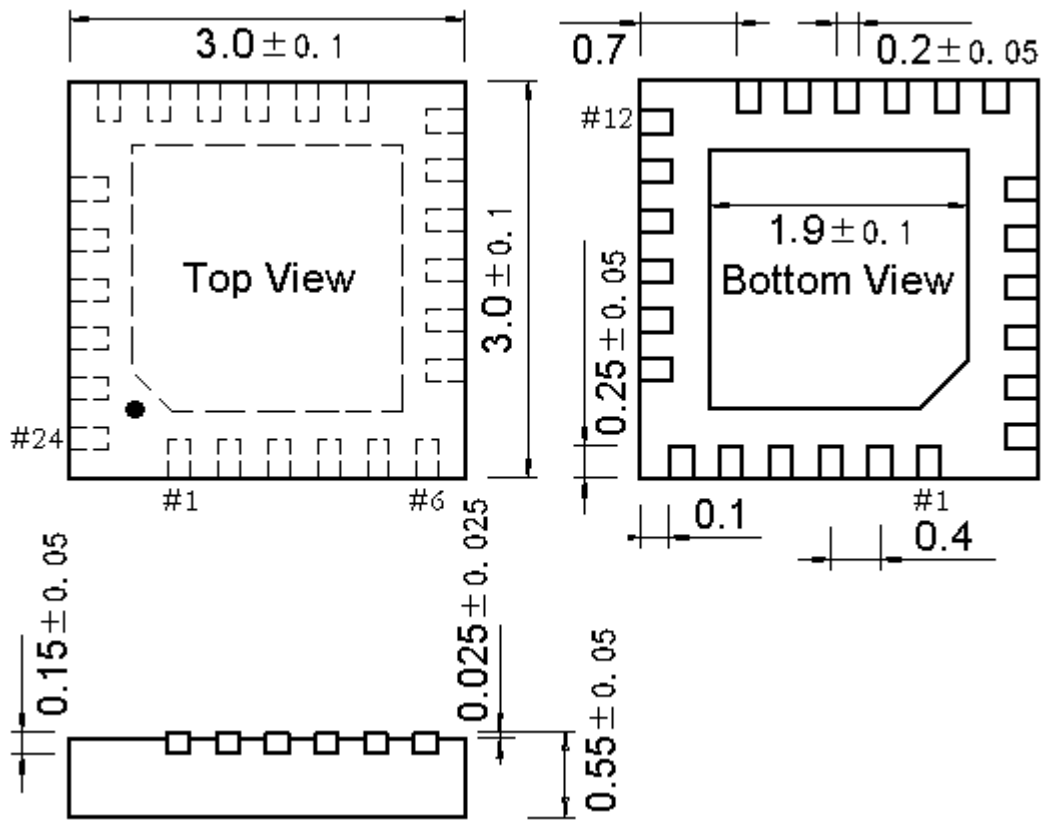

QFN26C3 (QFN26C-3*3*0.75-0.4)

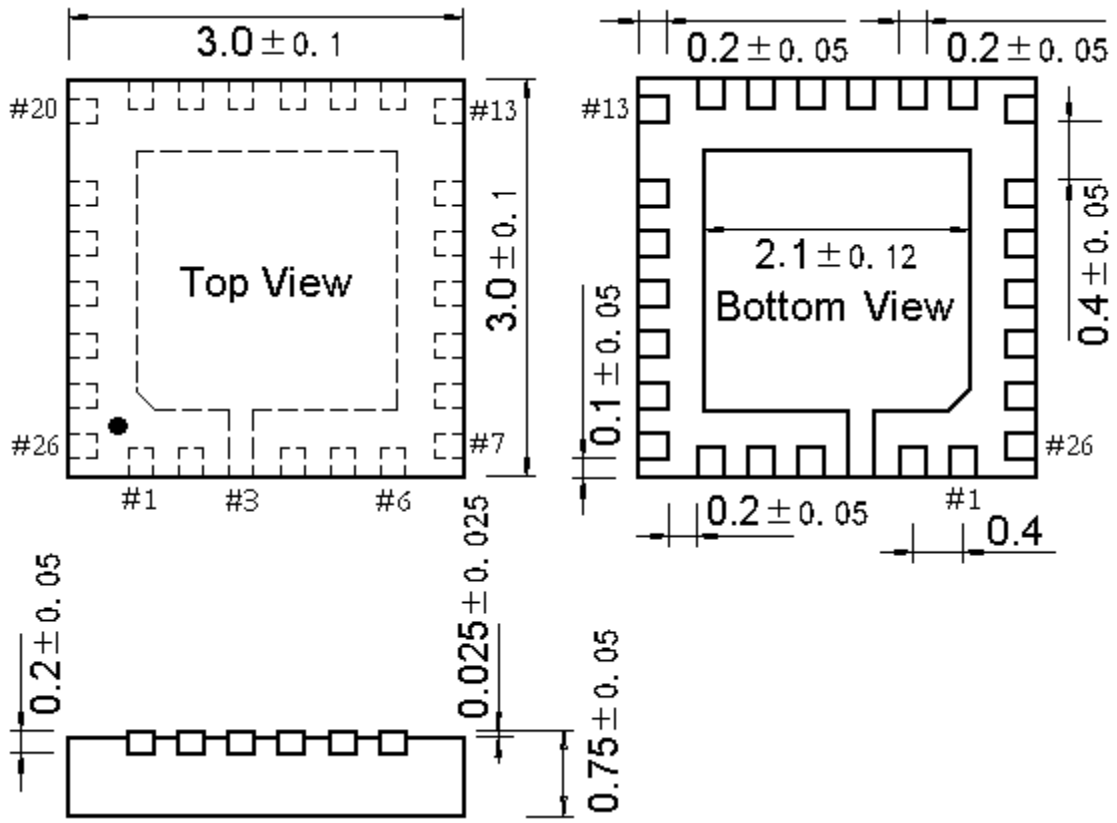

QFN28 (QFN28-4*4)

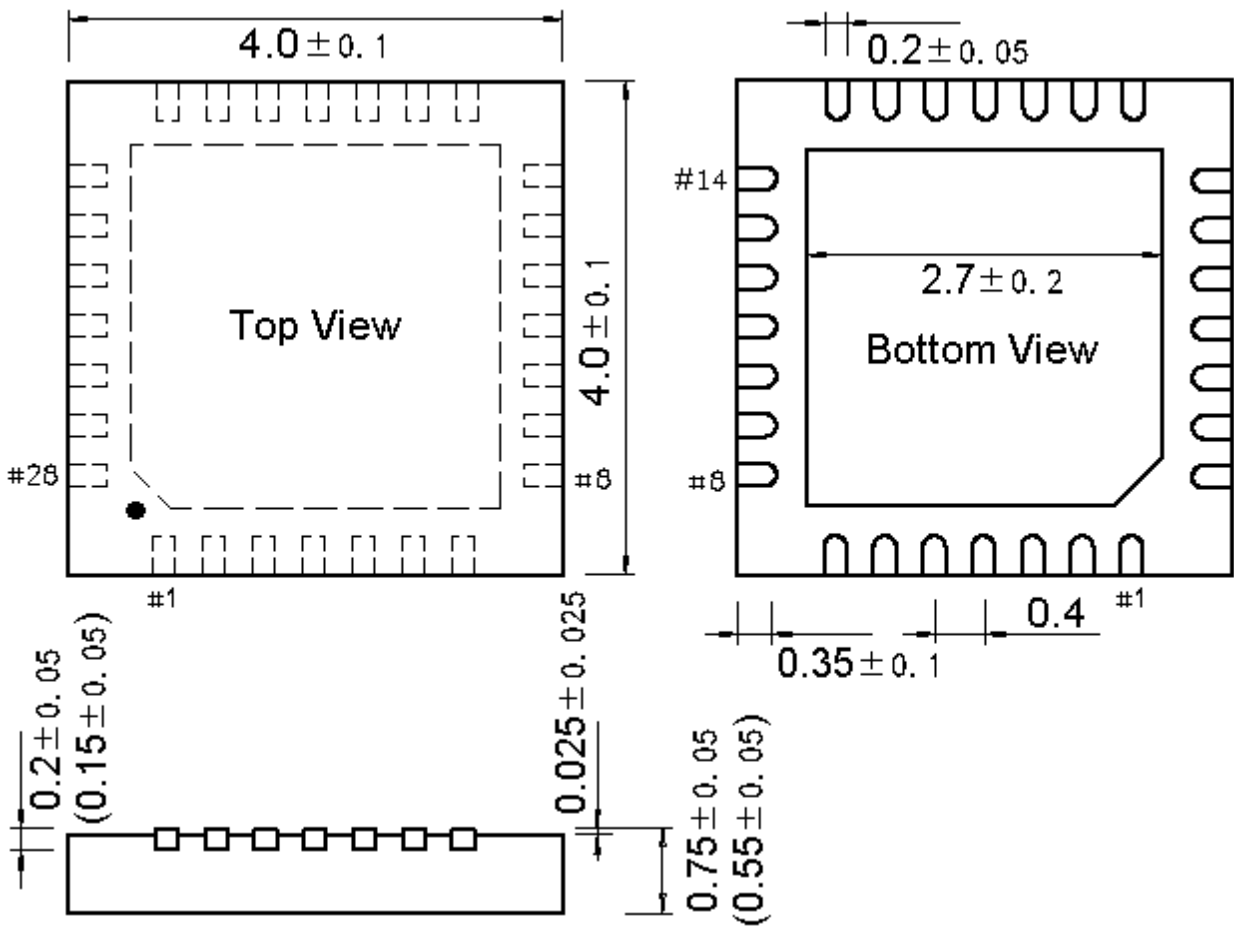

QFN28X5 (QFN28-5*5)

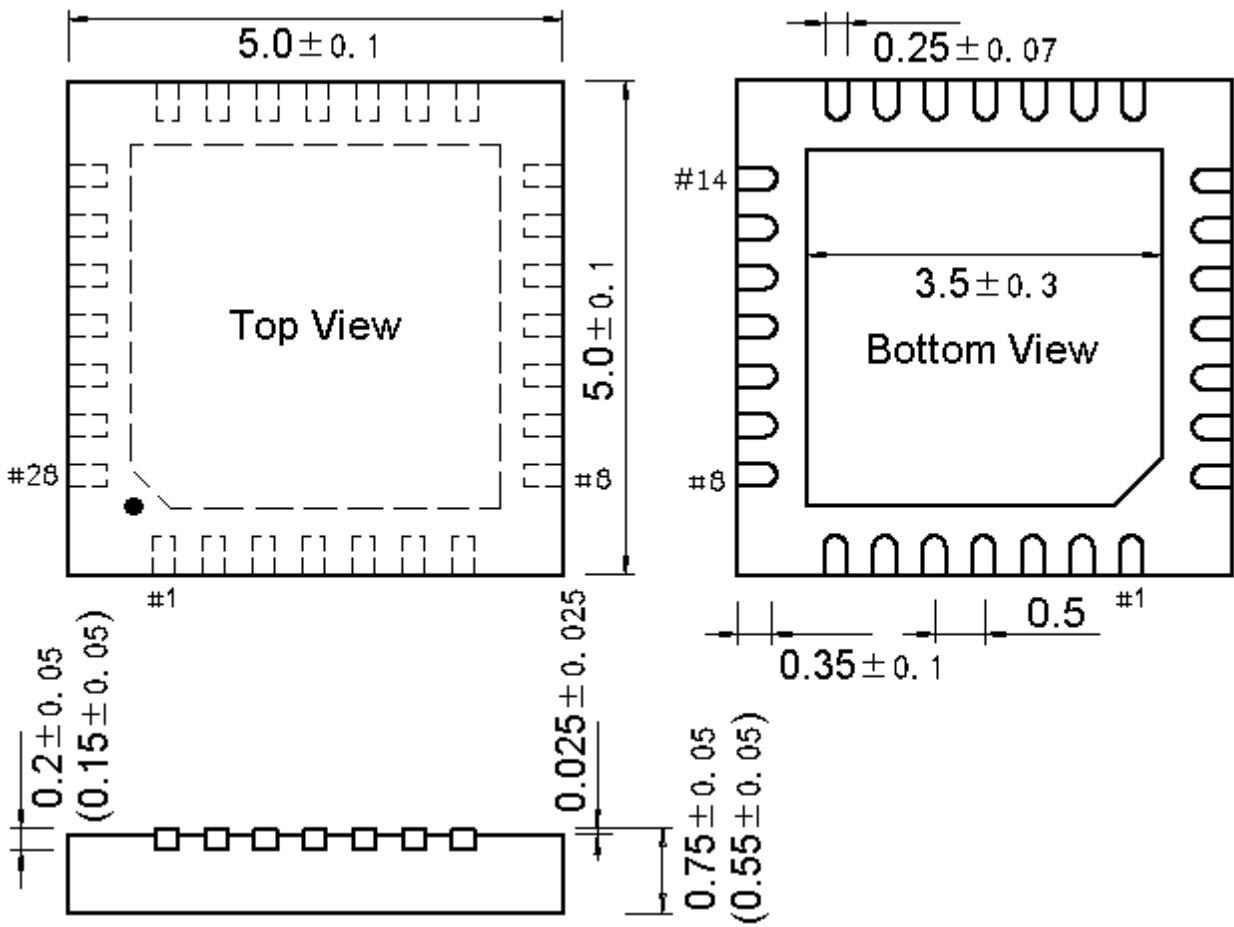

QFN32 (QFN32-4*4)

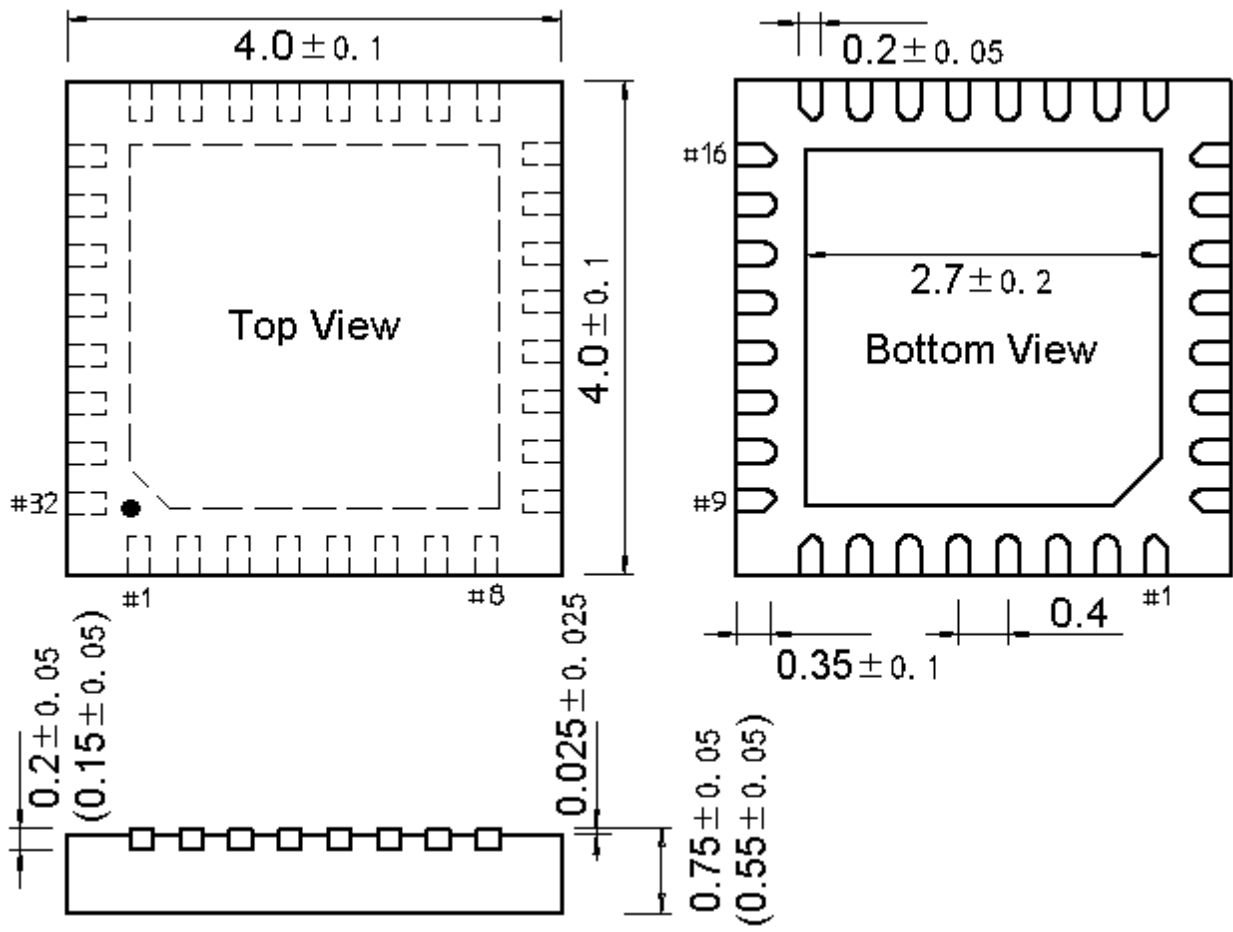

QFN32X5 (QFN32-5*5)

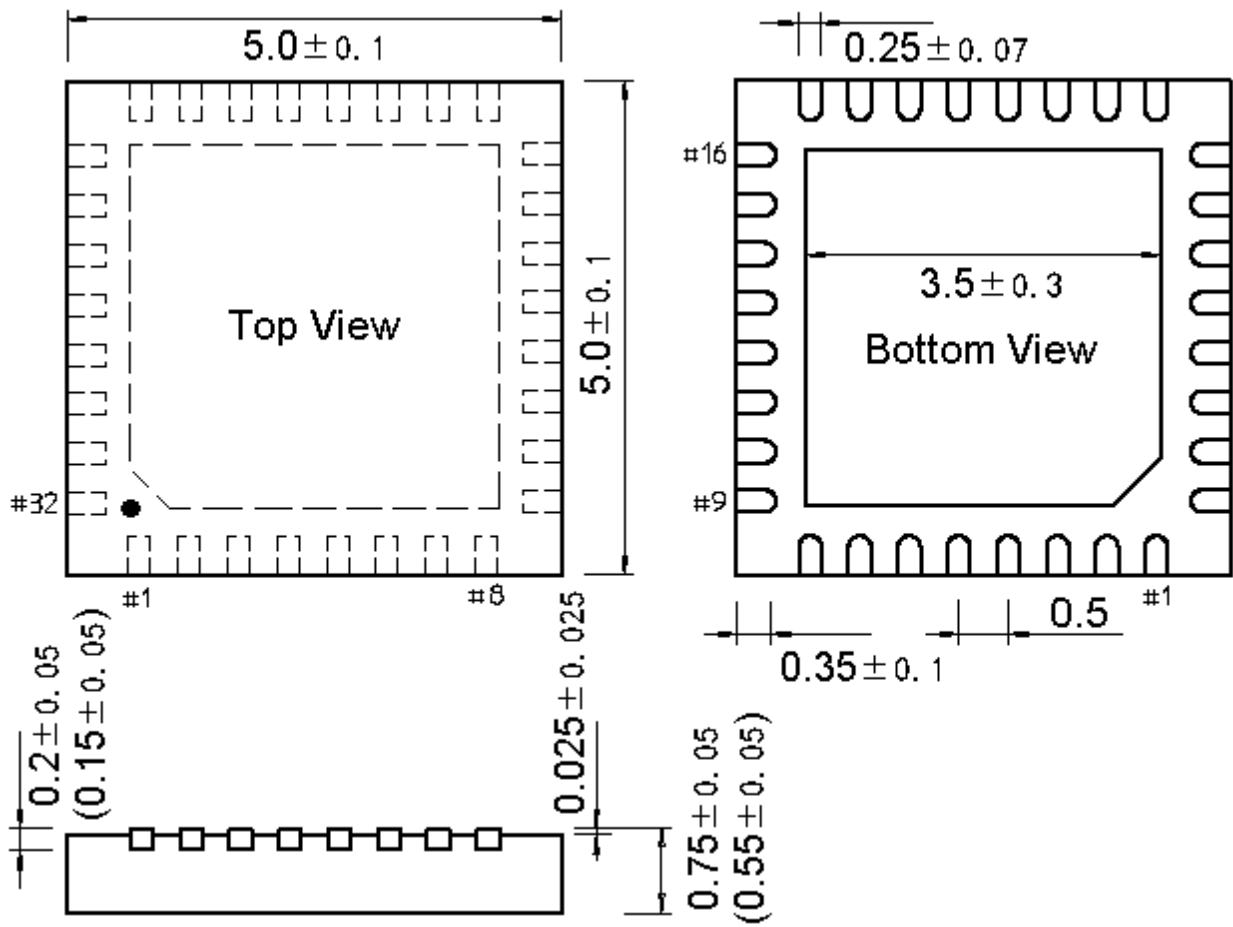

QFN32C28X45 (QFN32C-2.8*4.5*0.75-0.4)

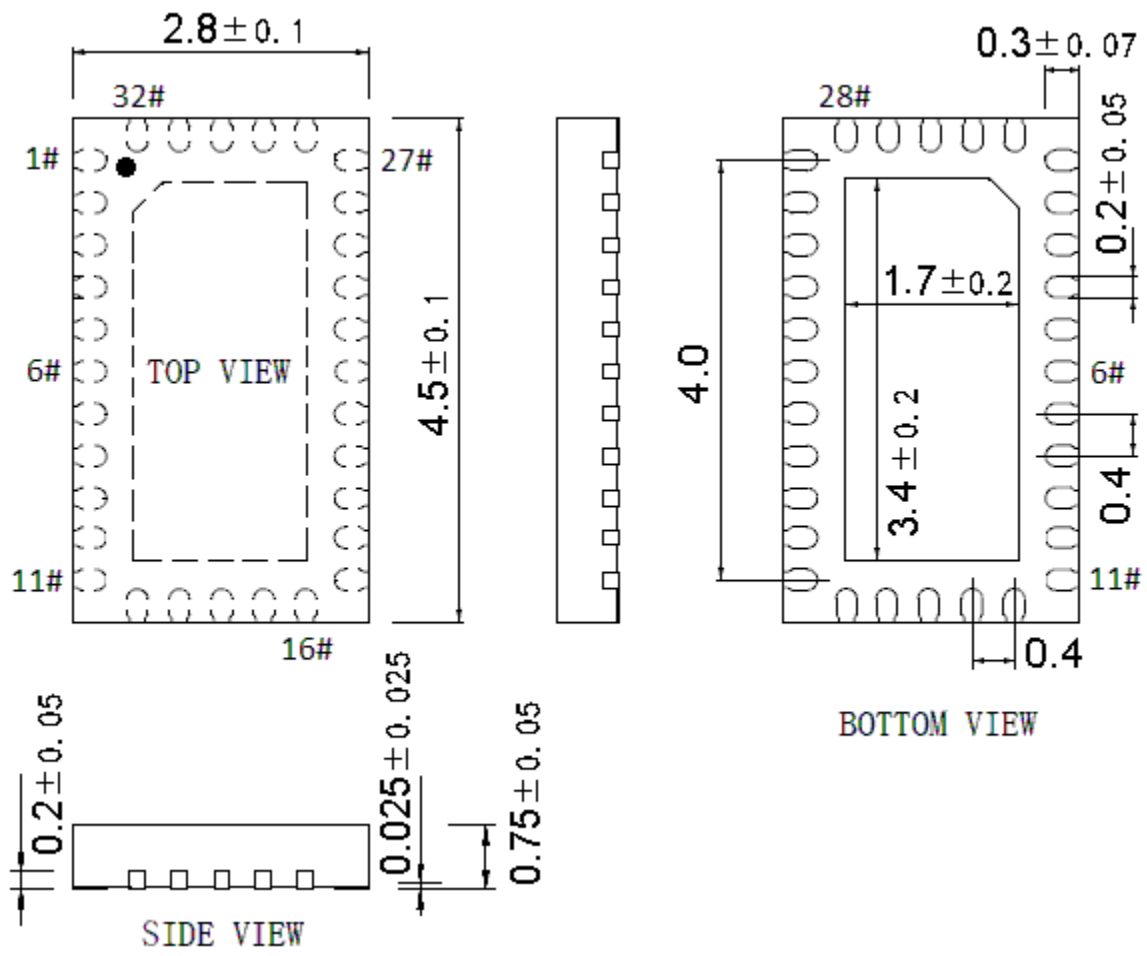

QFN36C4 (QFN36C-4*4*0.75-0.4)

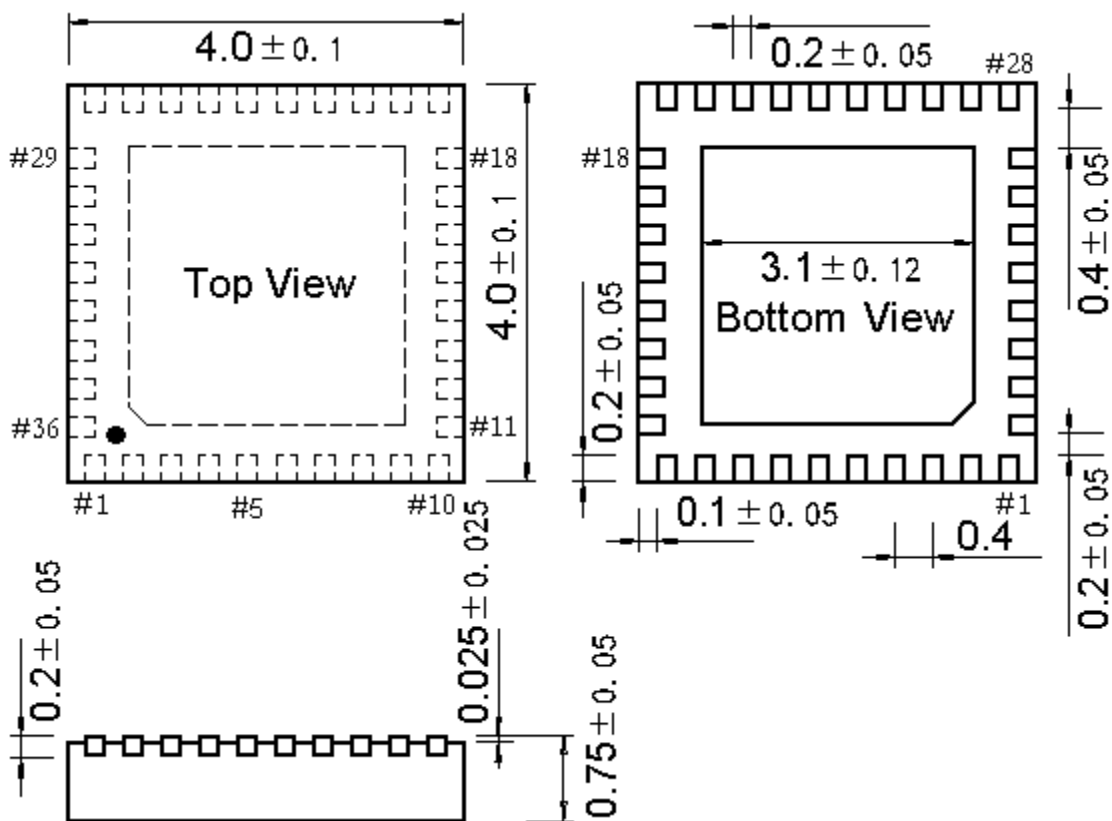

QFN36X6 (QFN36-6*6)

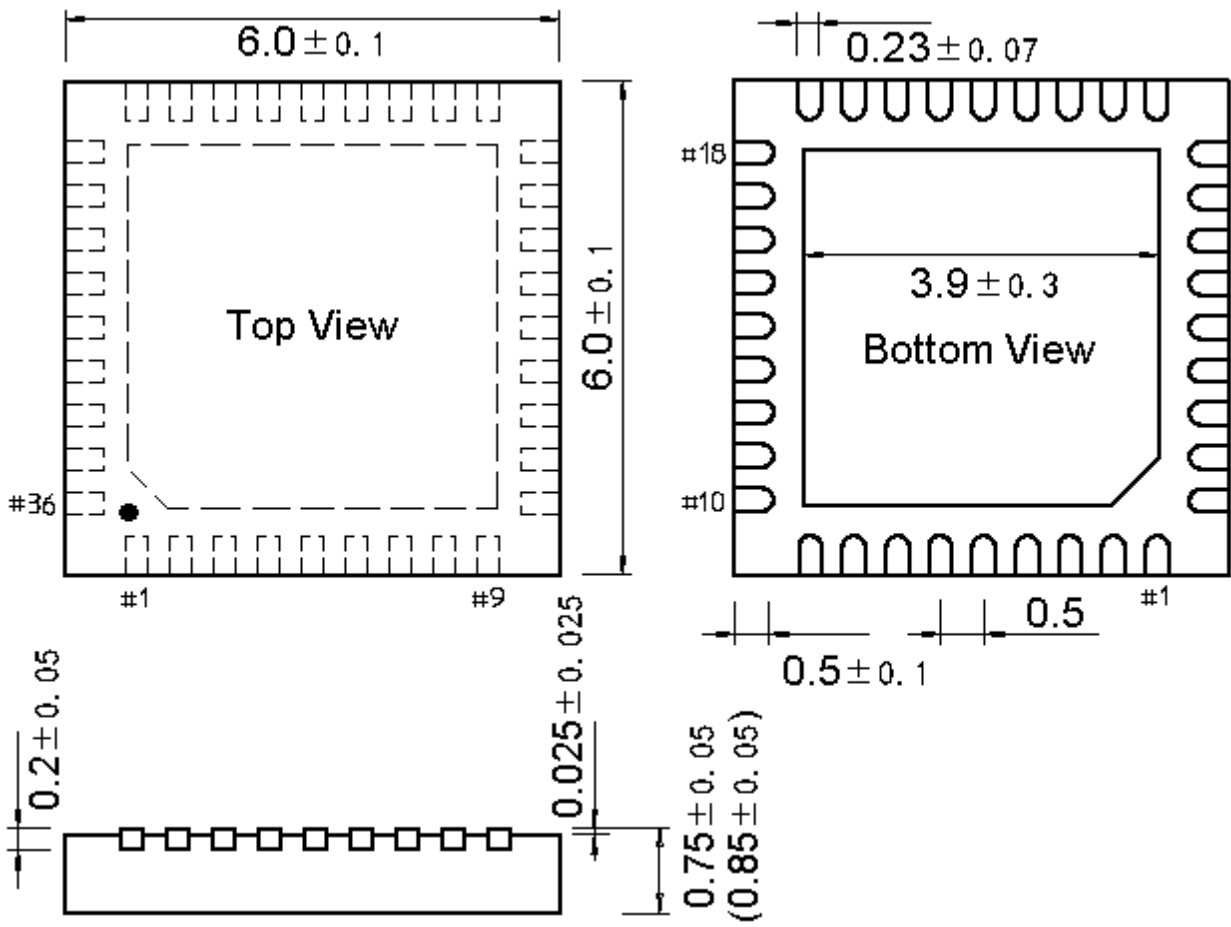

QFN40 (QFN40-5*5)

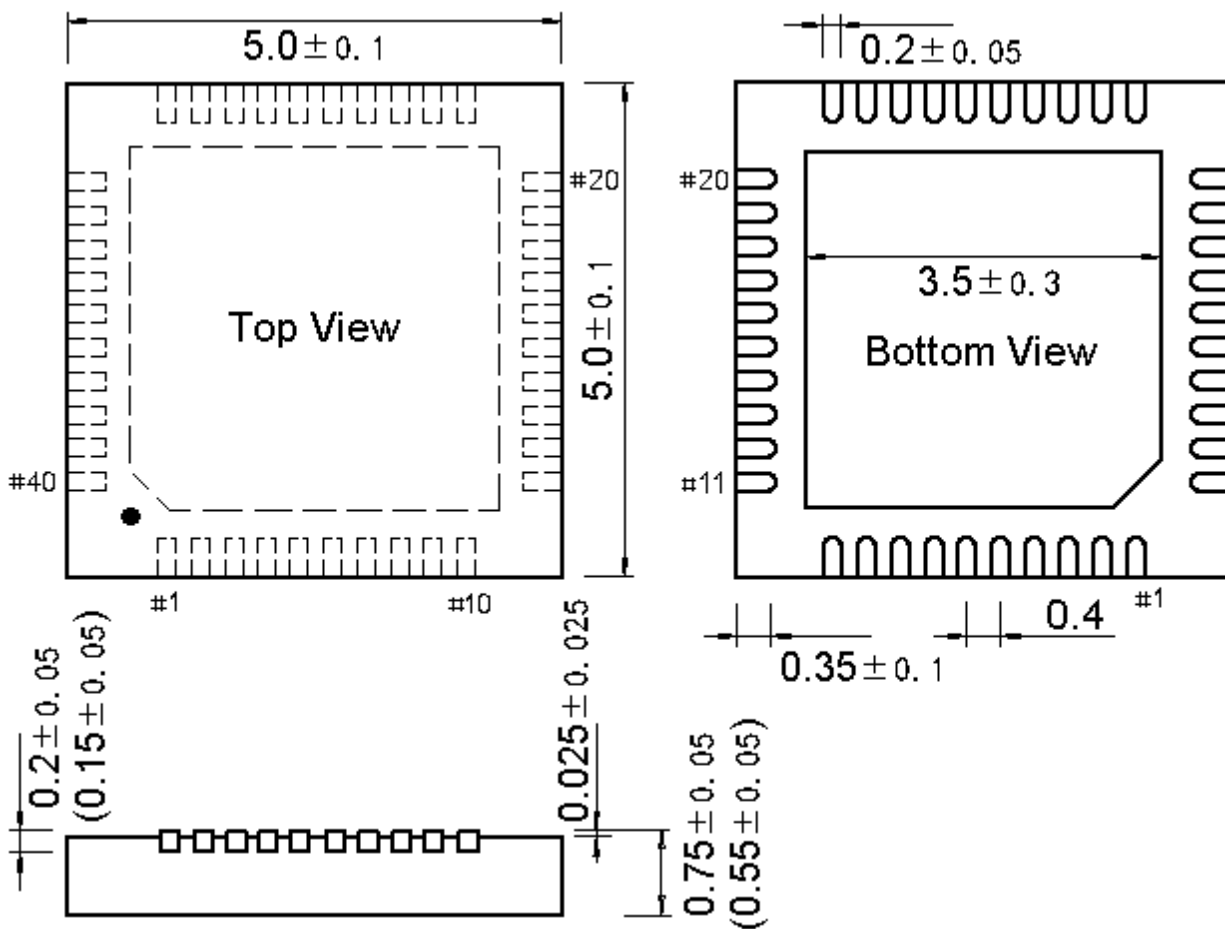

QFN40X6 (QFN40-6*6)

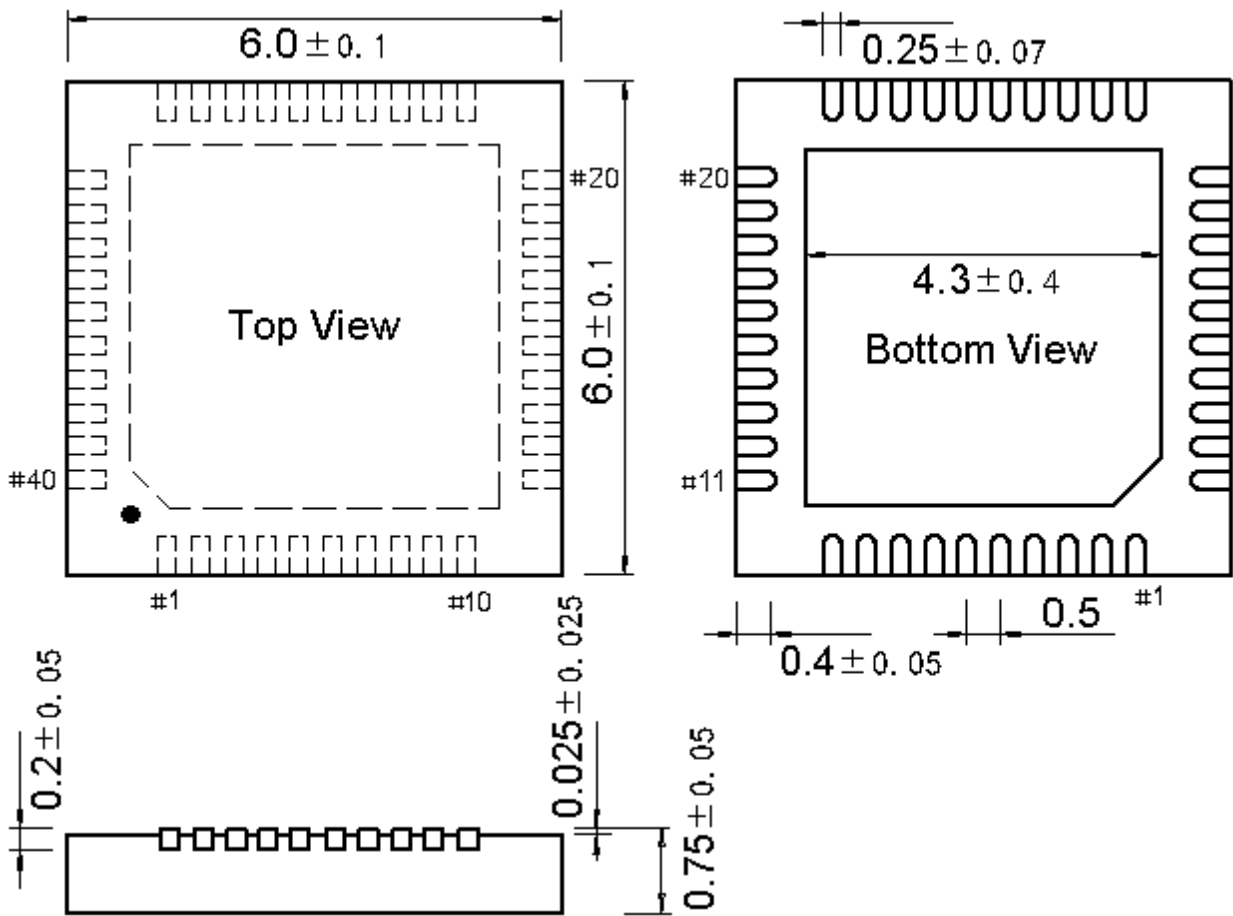

QFN42X35X9 (QFN42-3.5*9*0.75-0.5)

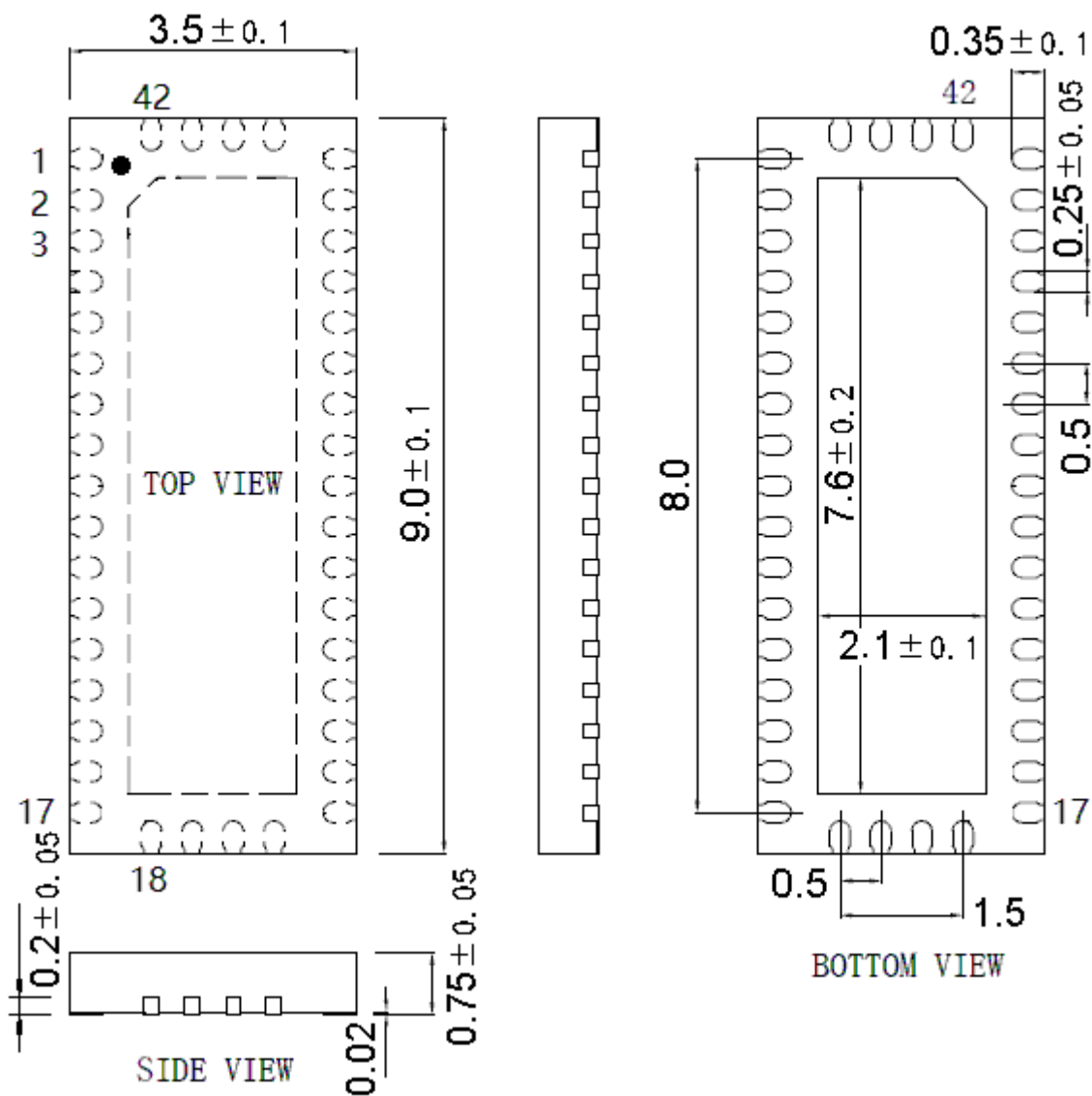

QFN42C35X9 (QFN42C-3.5*9*0.75-0.5)

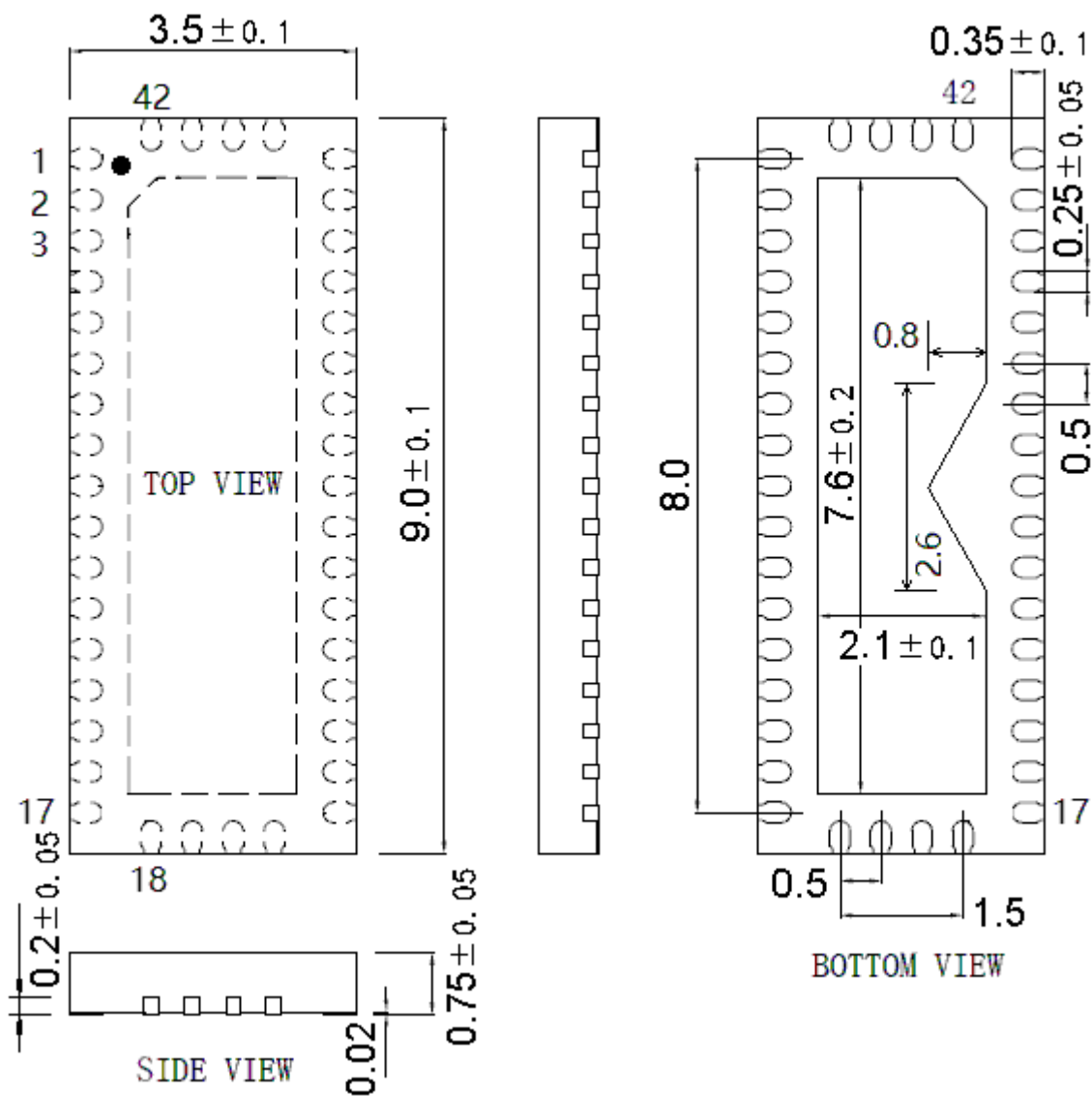

QFN46C5 (QFN46C-5*5*0.75-0.4)

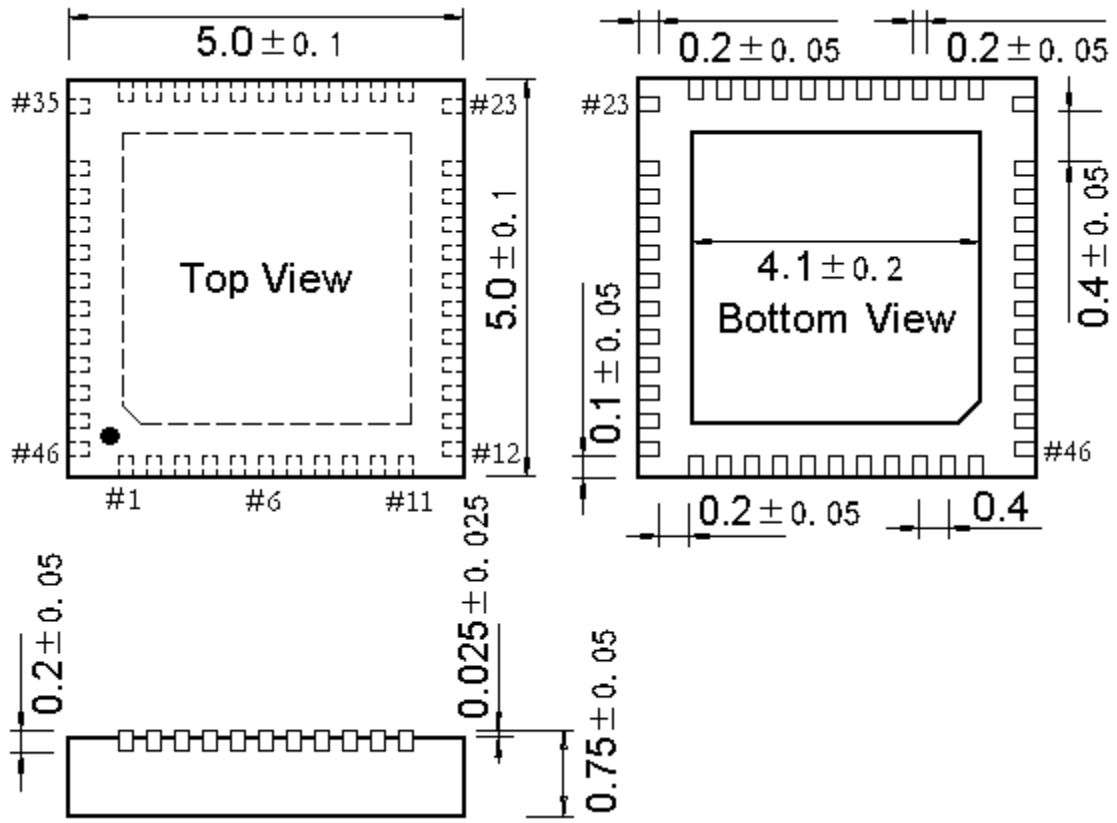

QFN48 (QFN48-5*5*0.75-0.35)

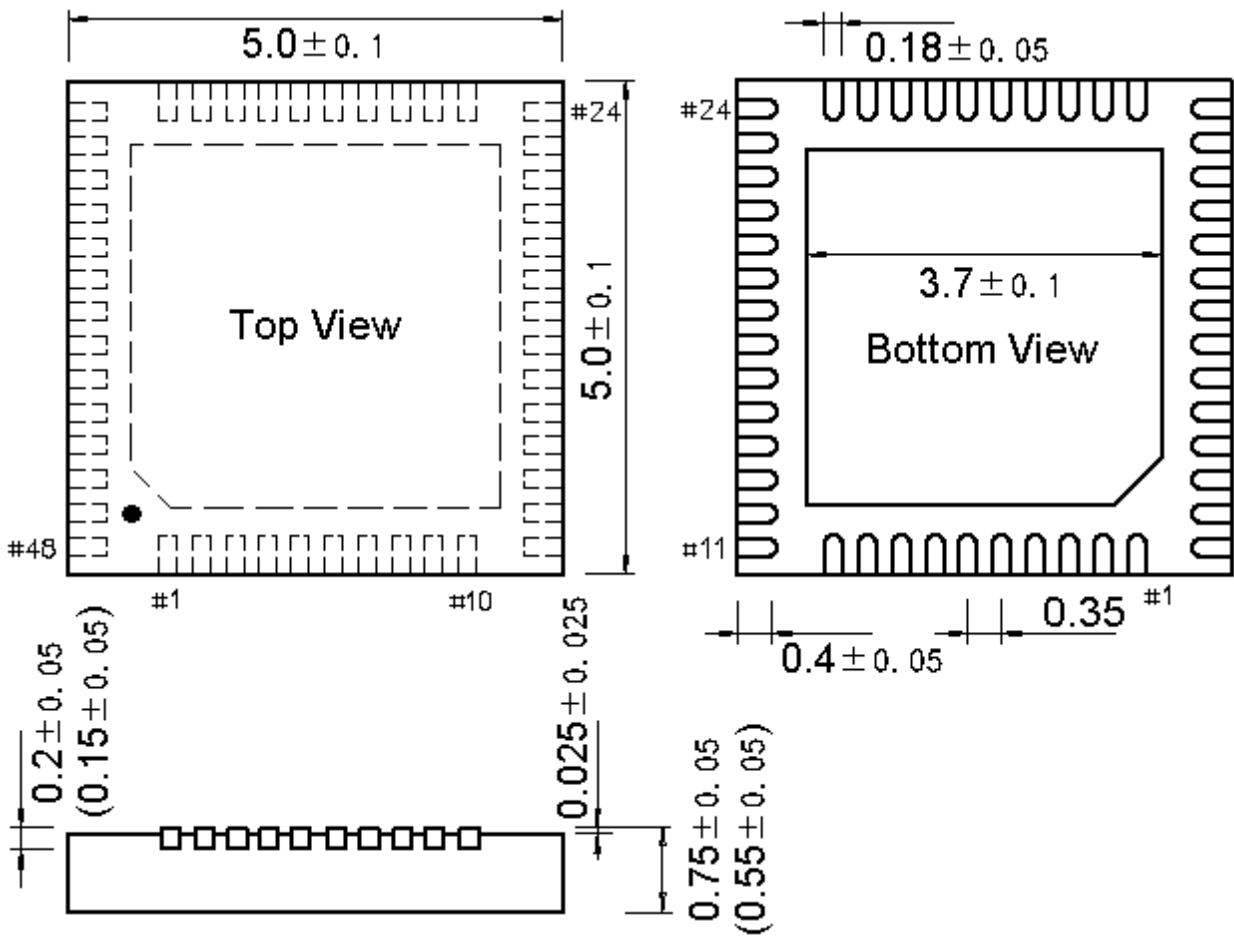

QFN48X6 (QFN48-6*6)

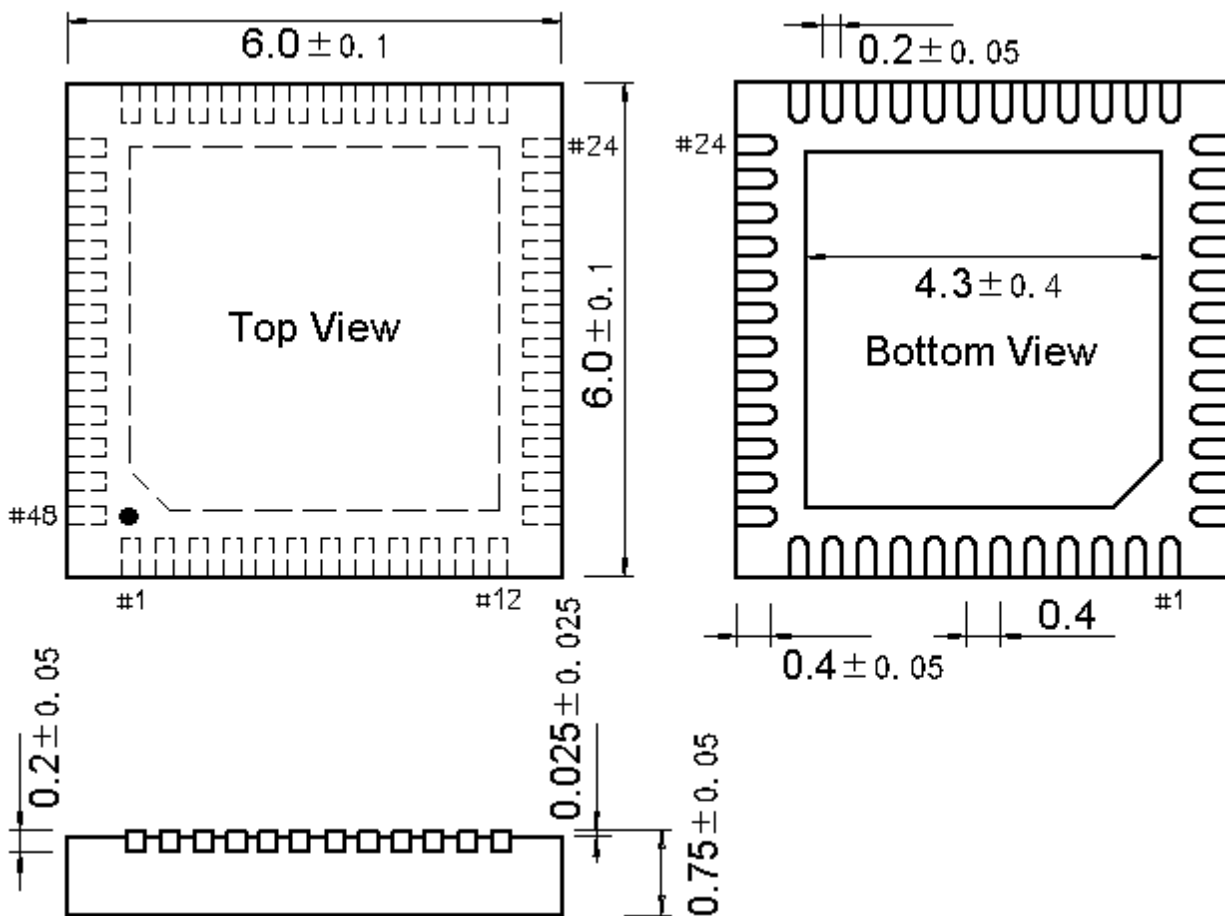

QFN48X7 (QFN48-7*7)

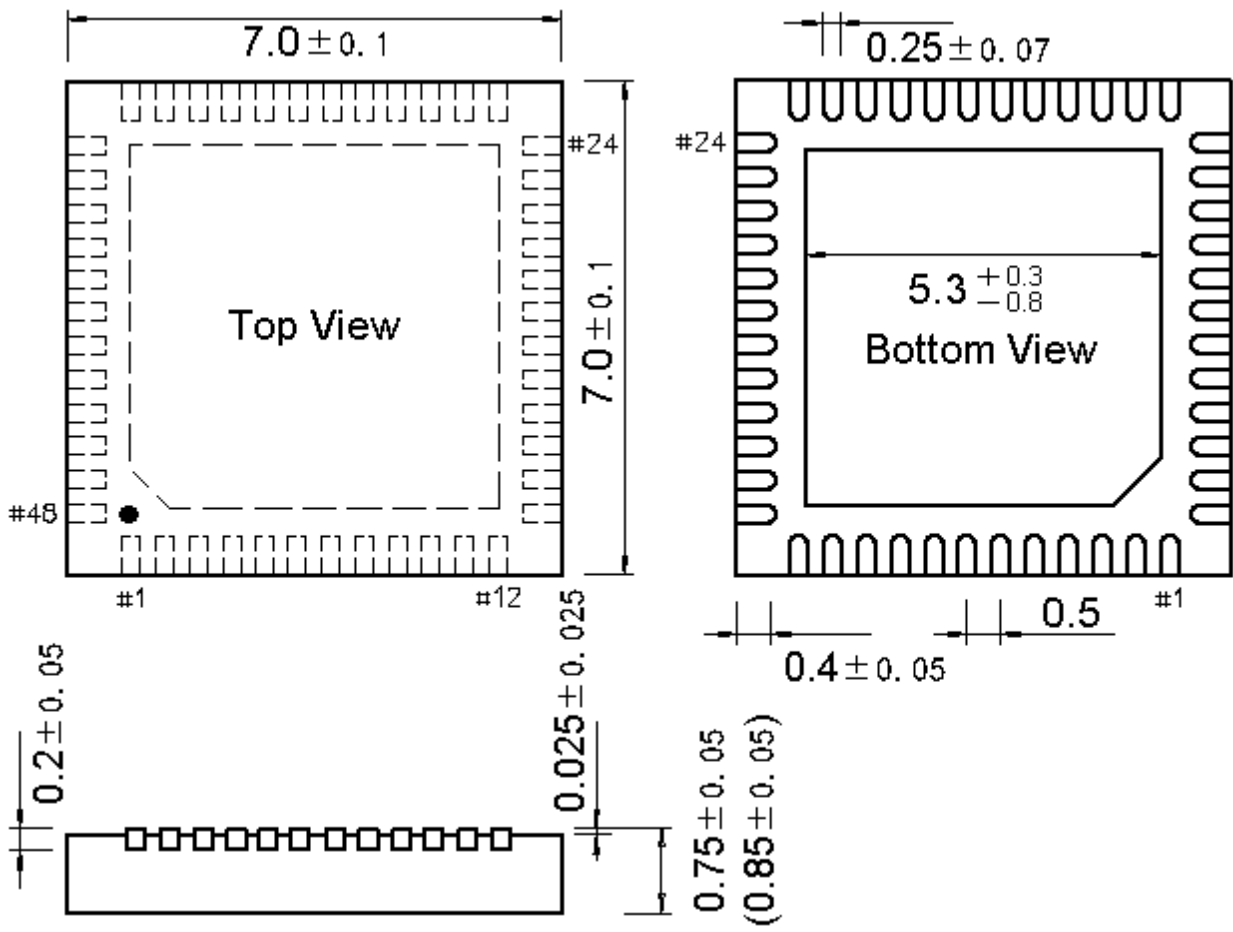

QFN56 (QFN56-7*7)

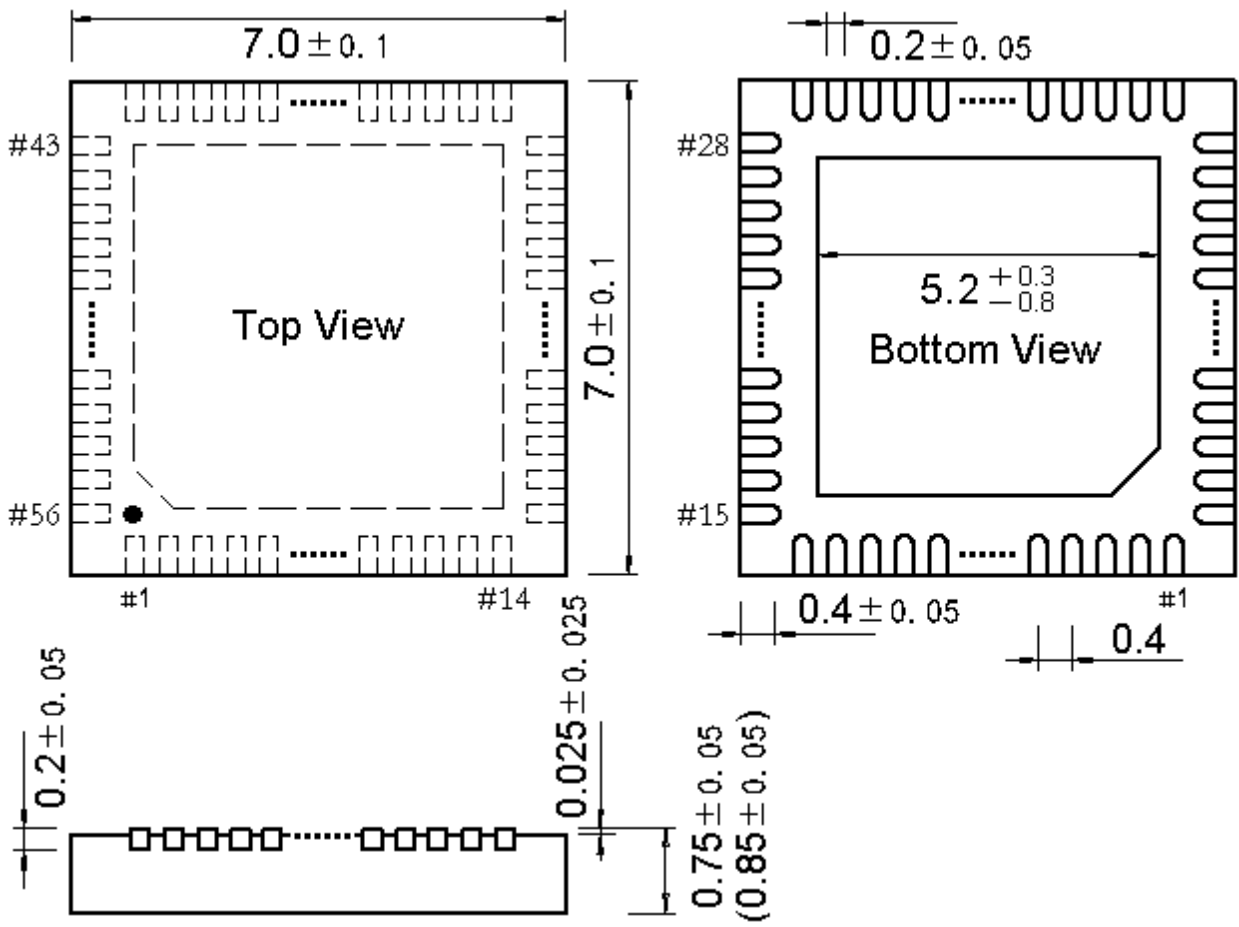

QFN56X8 (QFN56-8*8)

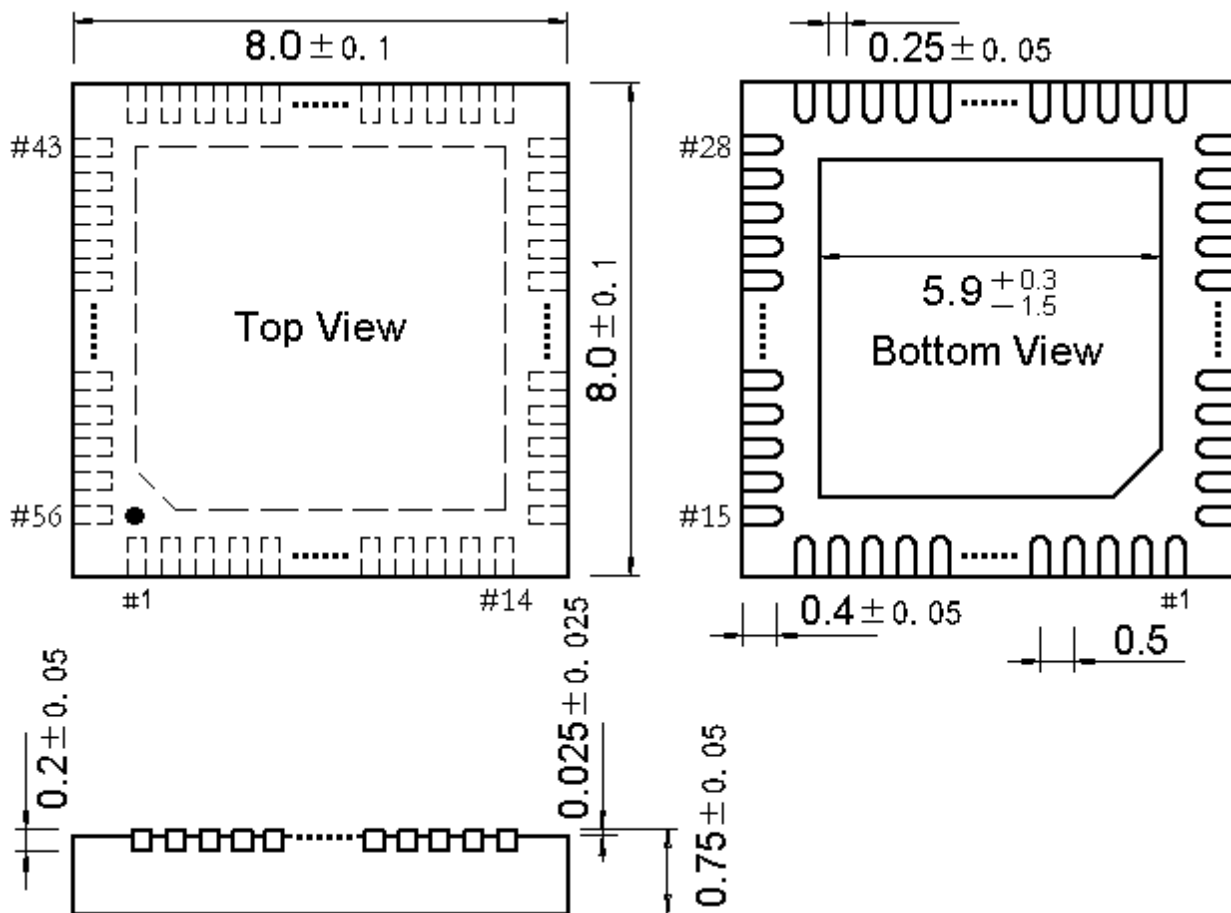

QFN64 (QFN64-8*8)

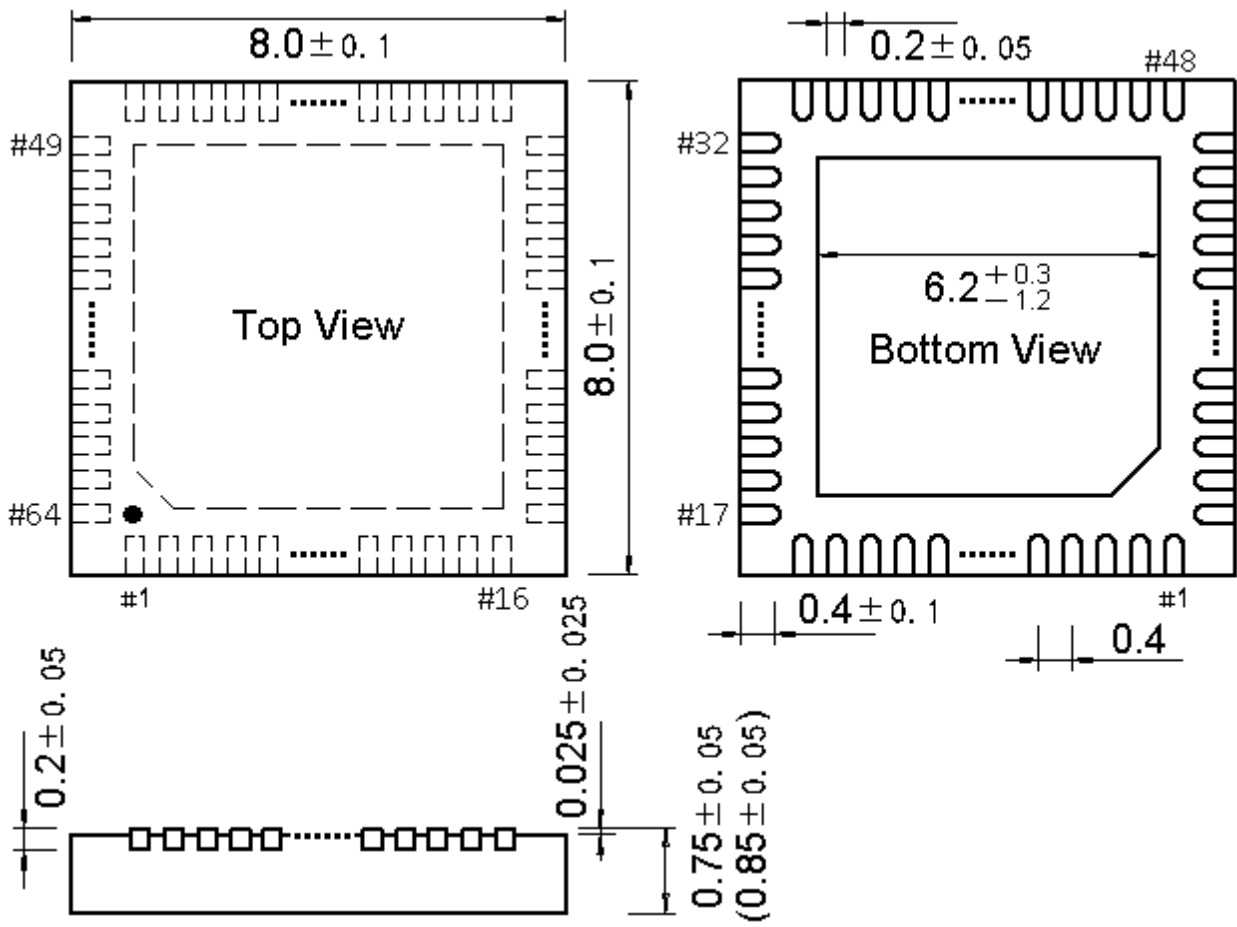

QFN64X9 (QFN64-9*9)

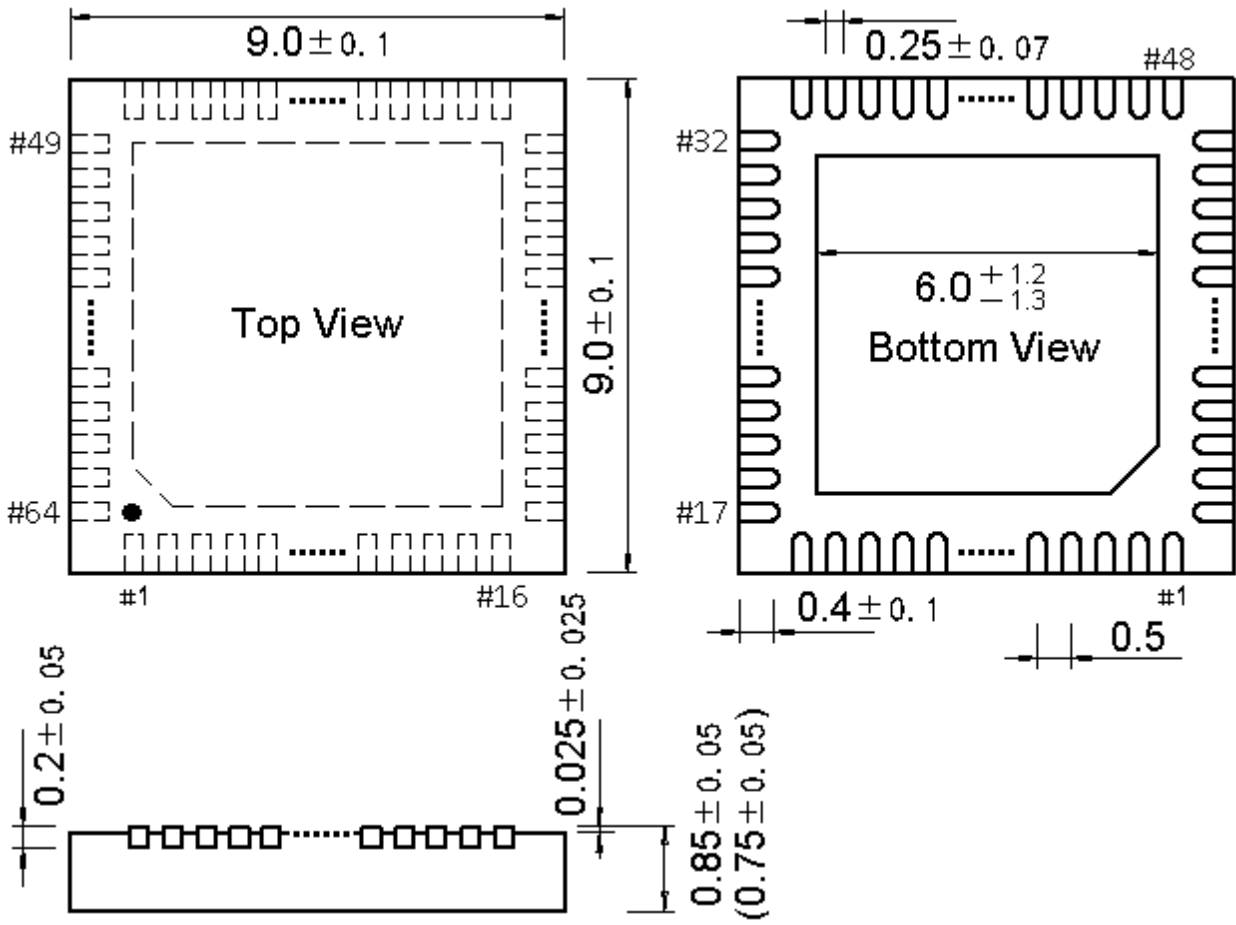

QFN68 (QFN68-8*8)

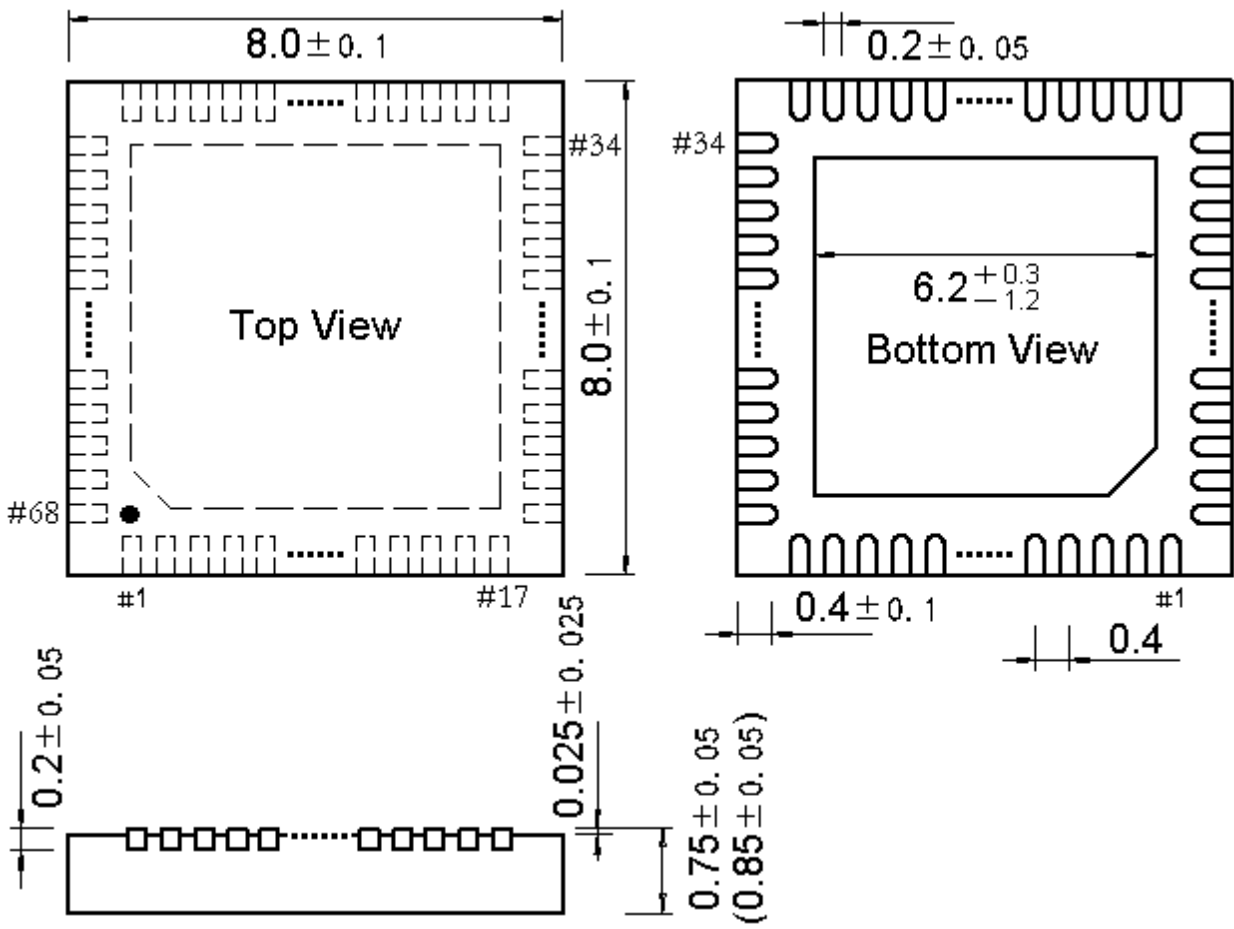

QFN76 (QFN76-9*9)

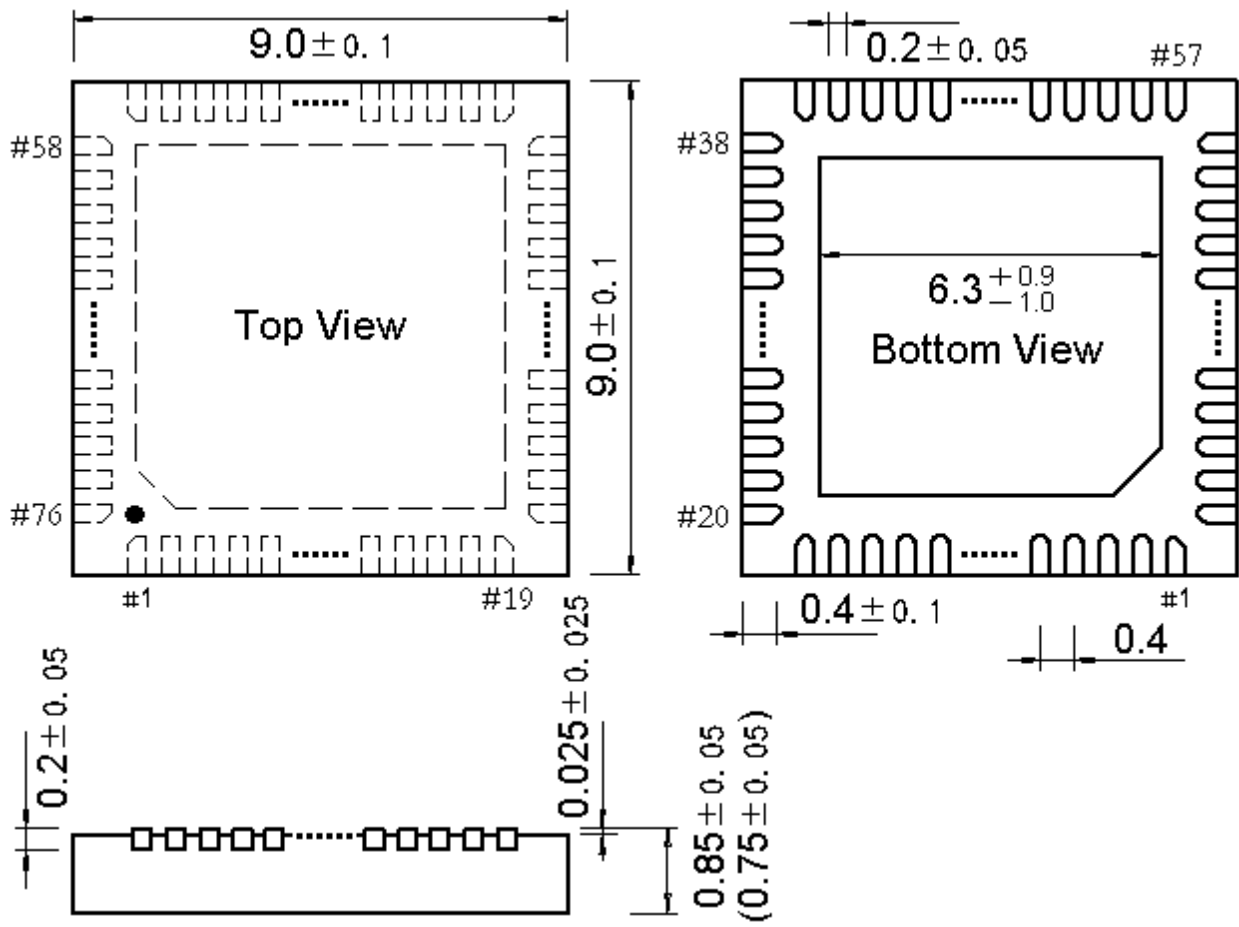

QFN80 (QFN80-9*9)

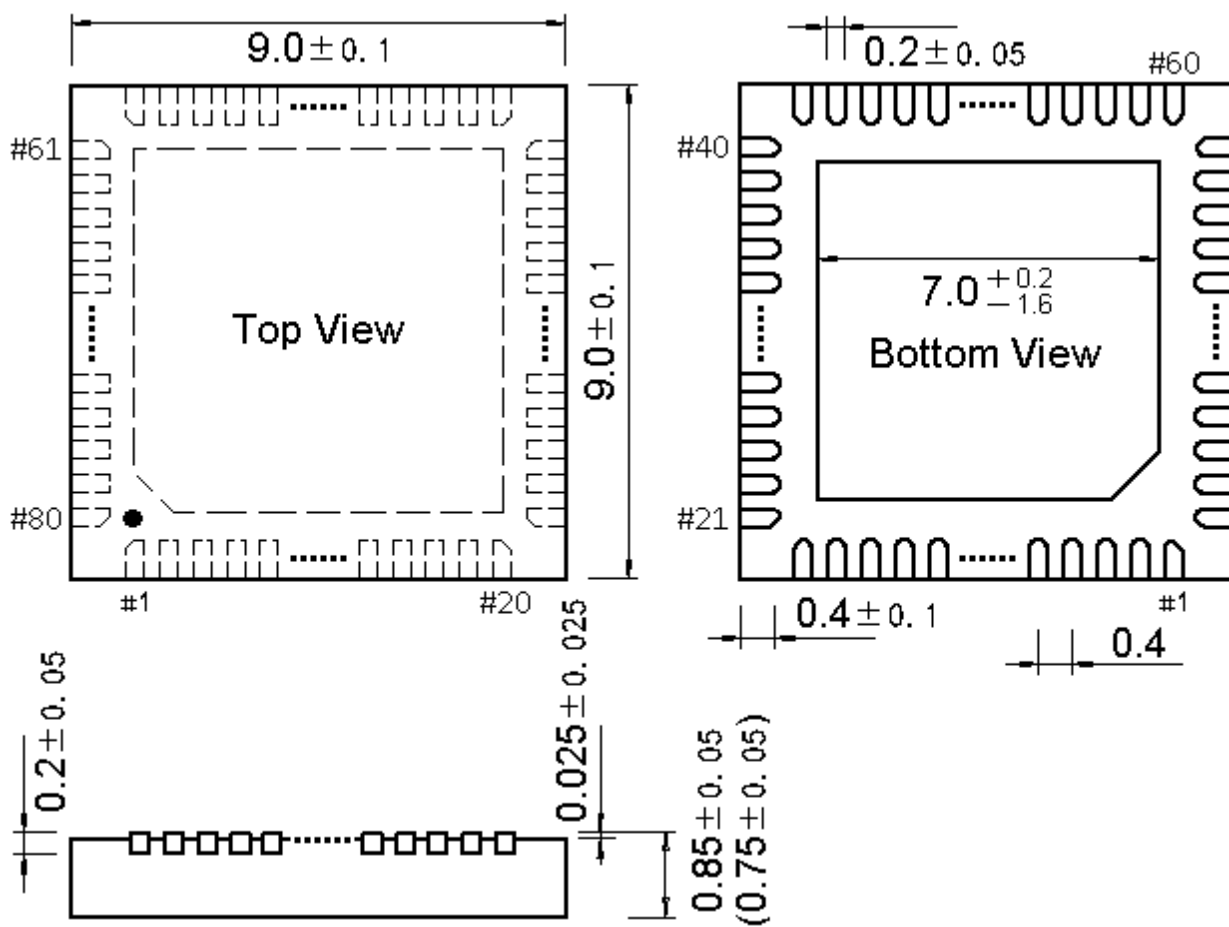

QFN88 (QFN88-10*10)

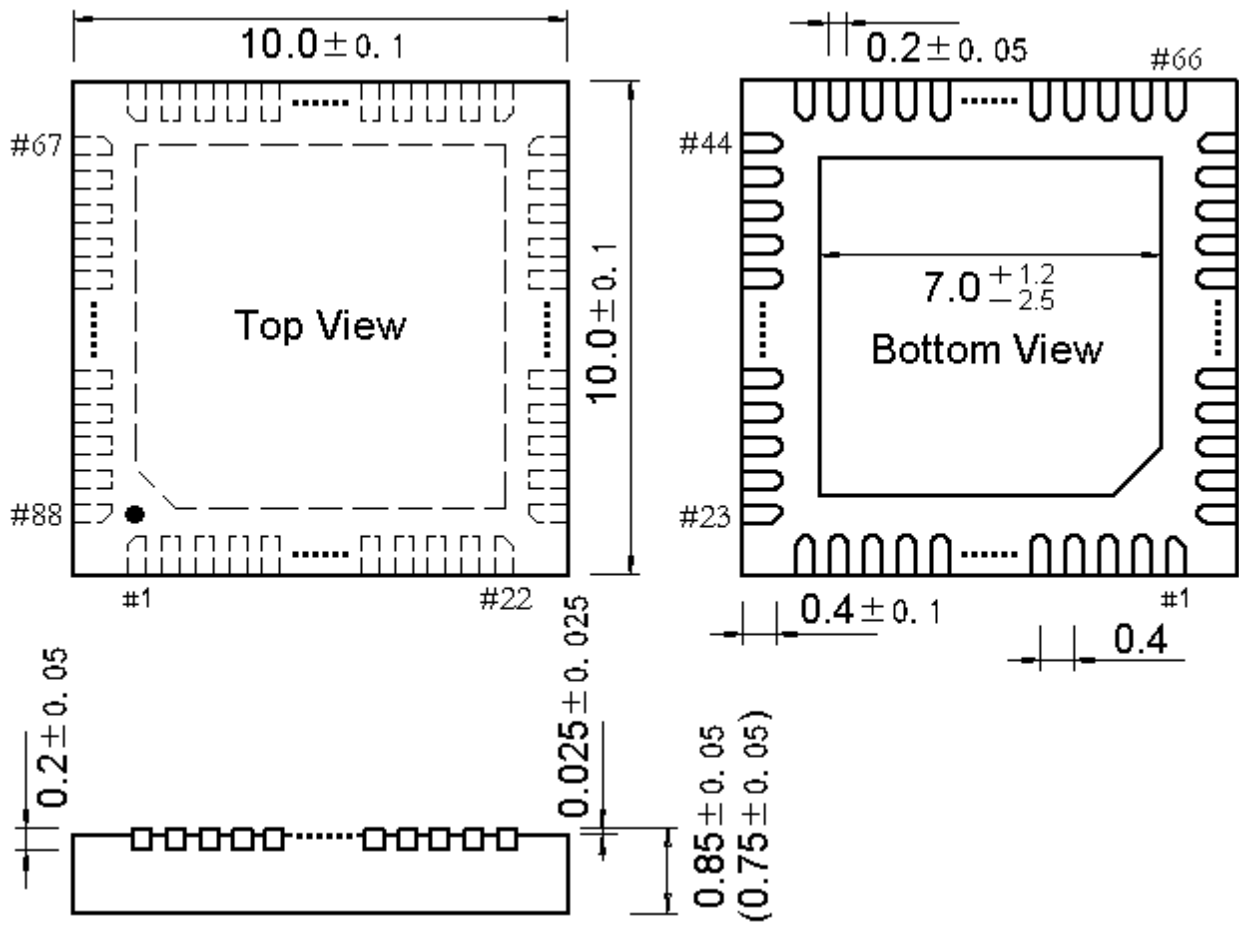

DFN 类

DFN6L12 (DFN6-1.2*1.2*0.4-0.4)

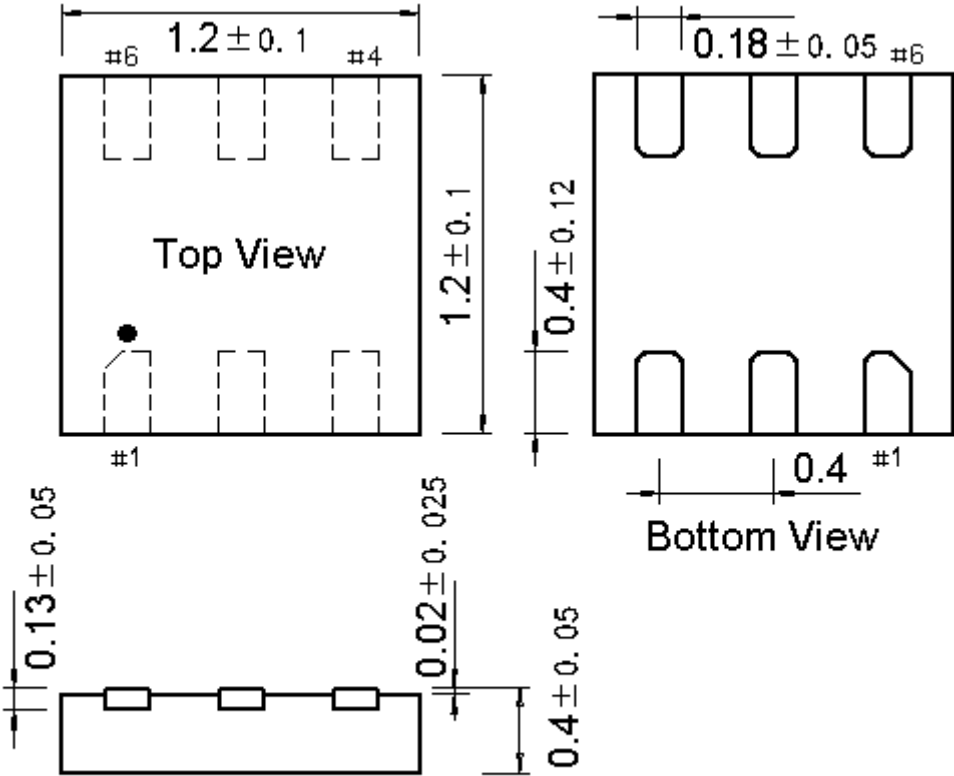

DFN6 (DFN6-2*2)

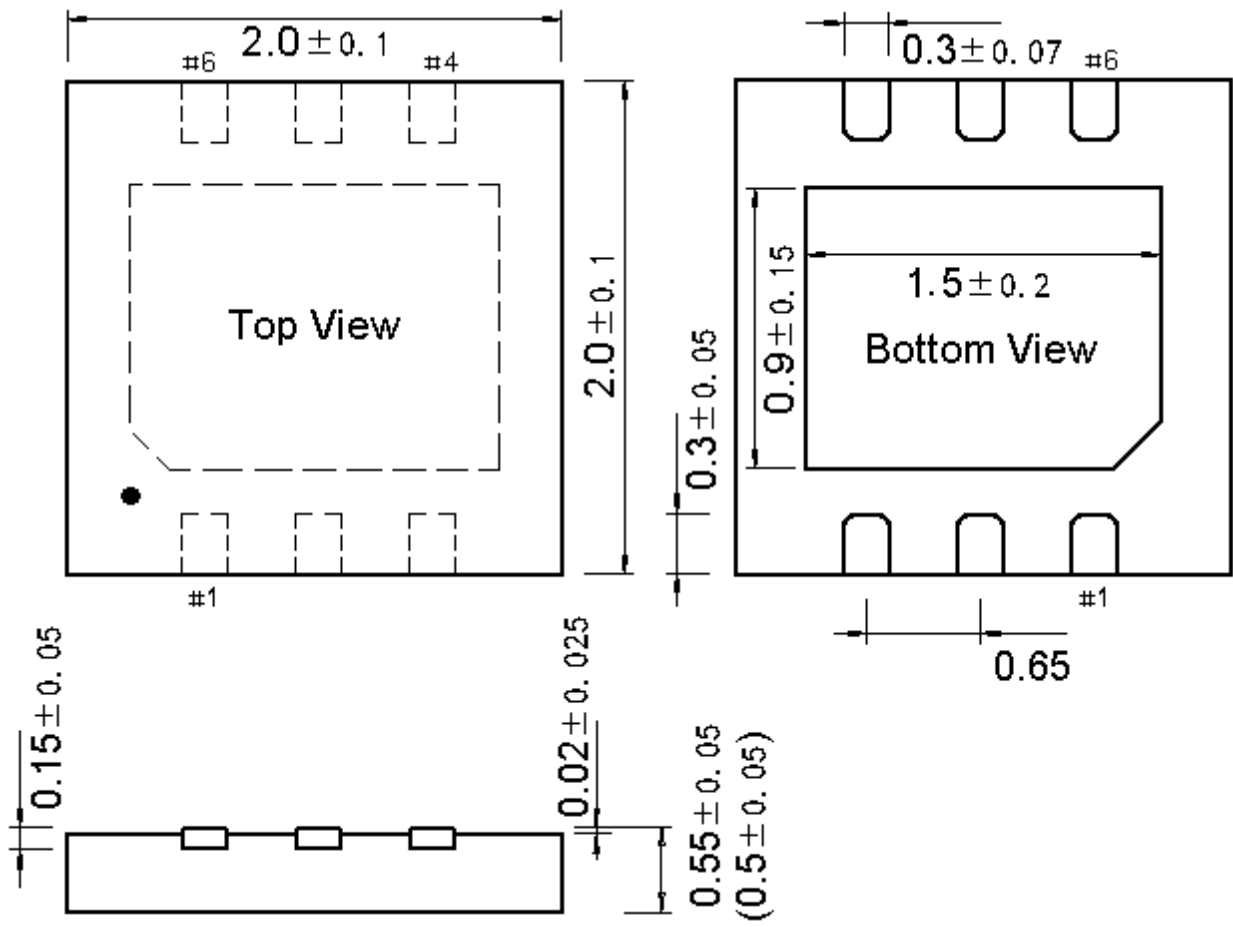

DFN8 (DFN8-2*2)

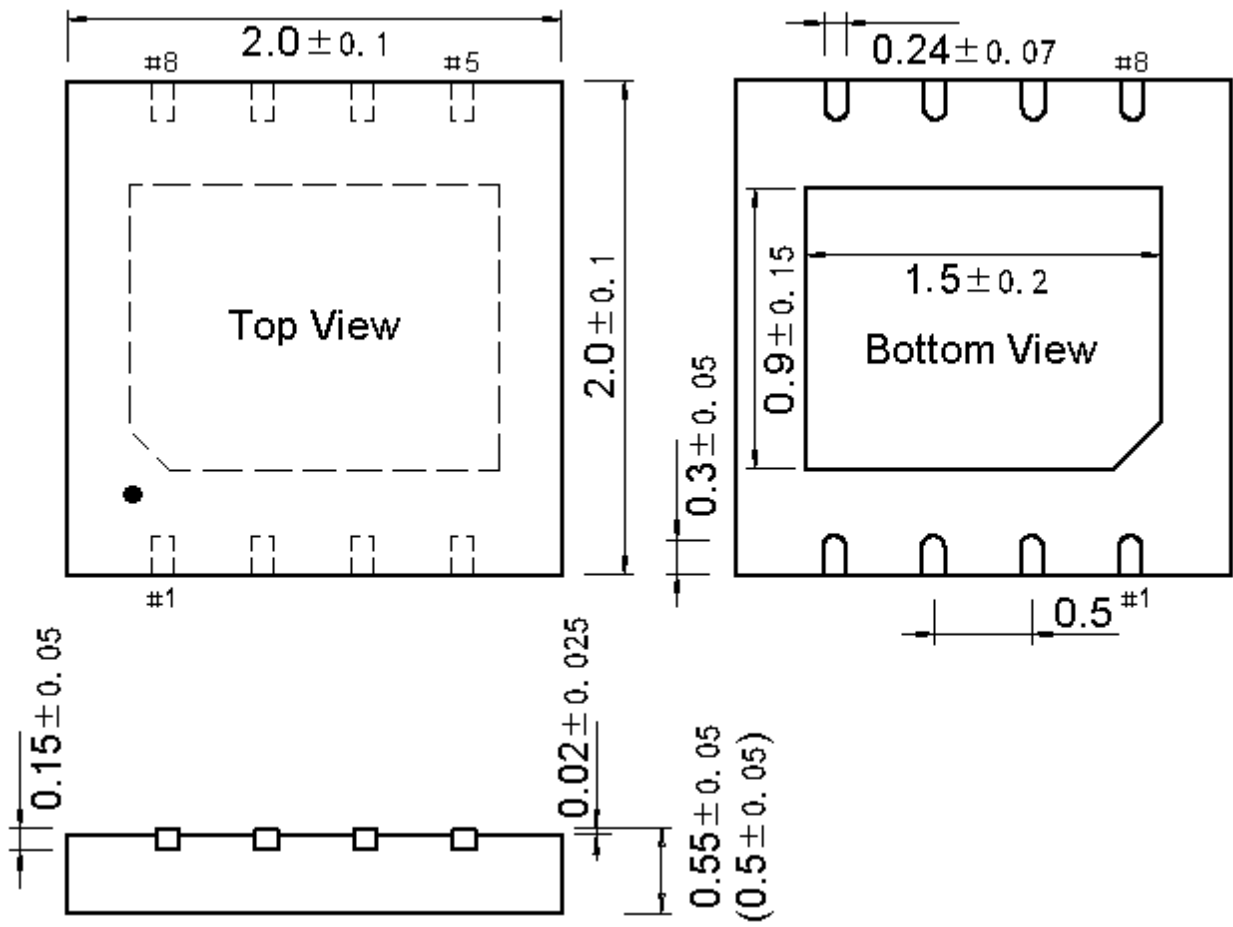

DFN10 (DFN10-2*2)

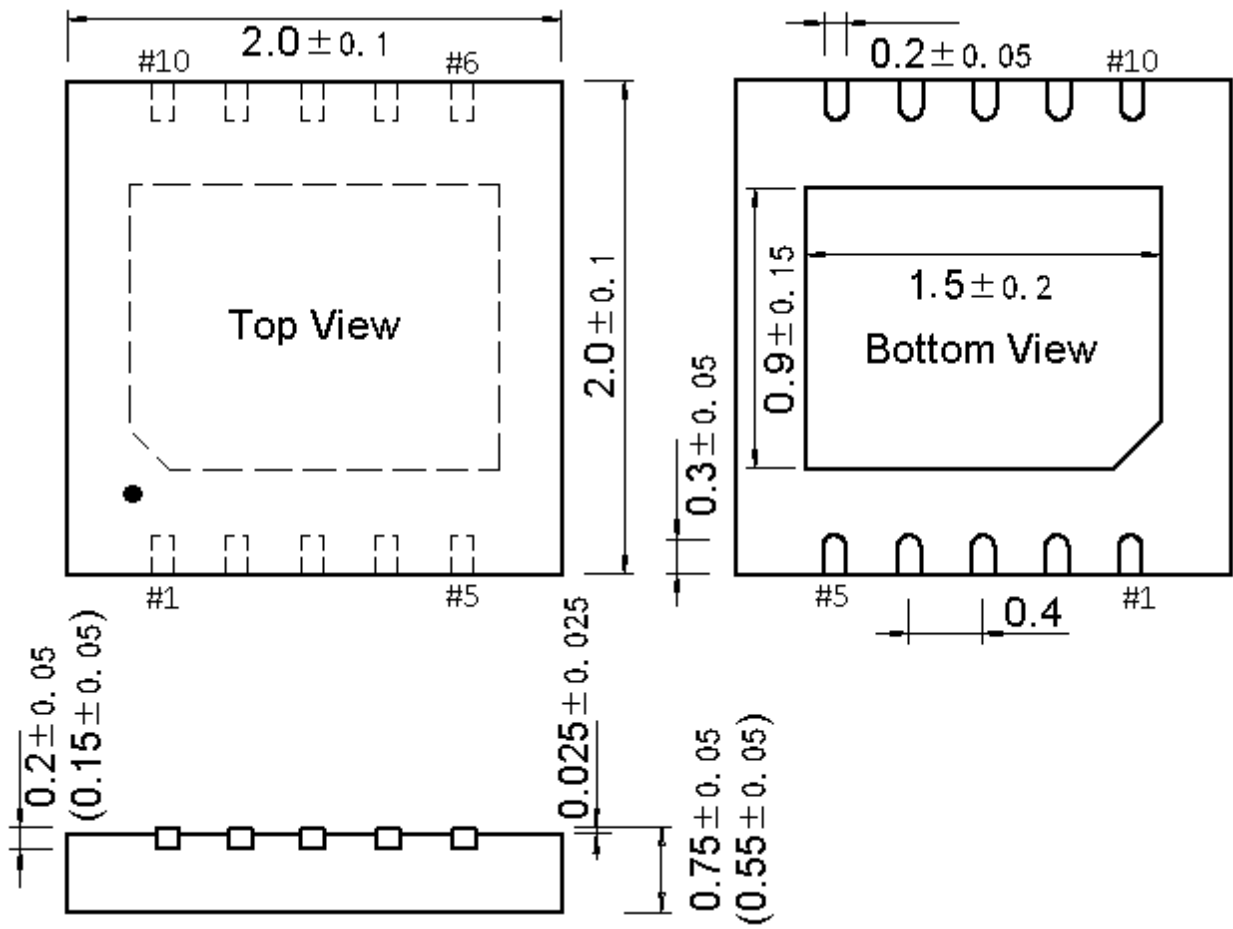

DFN10X3 (DFN10-3*3)

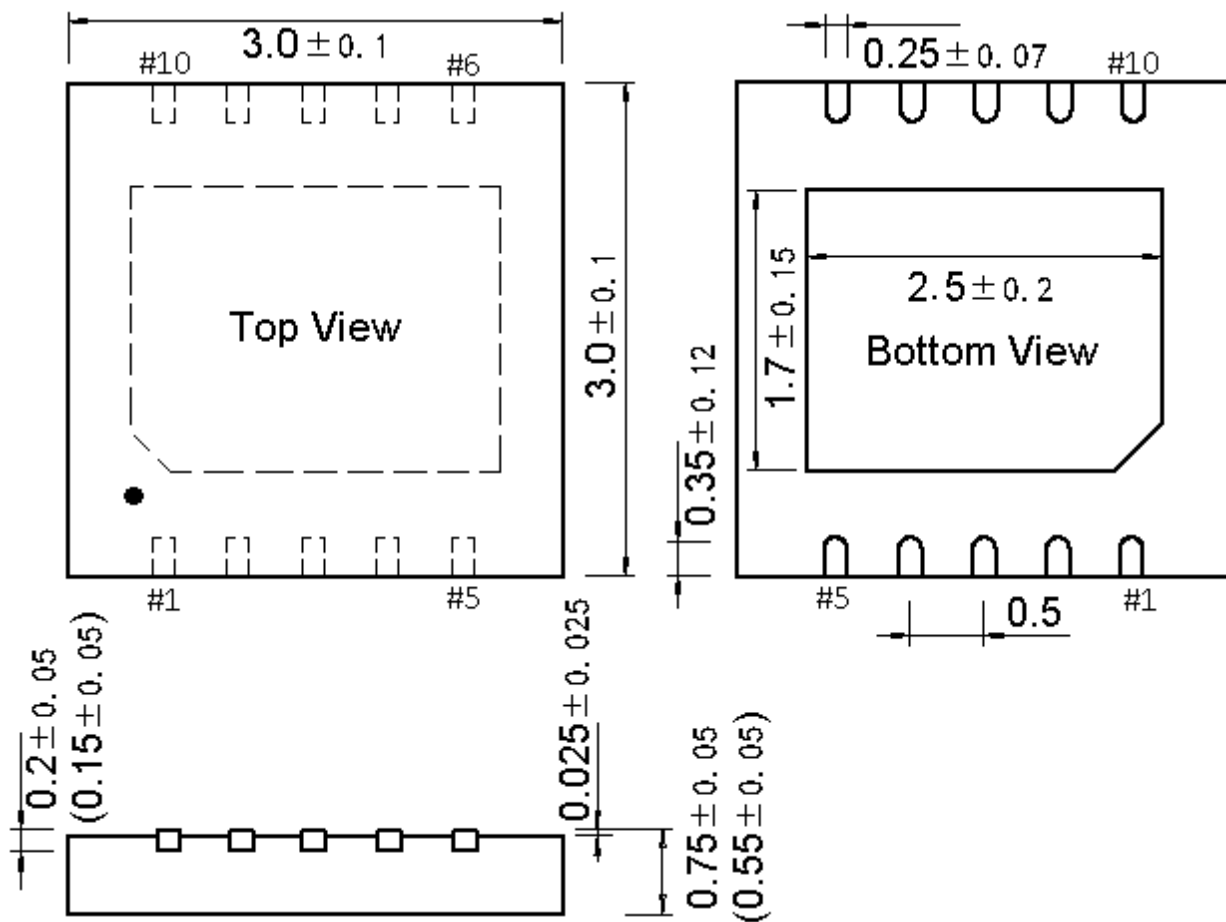

SOT 类

SOT23-3

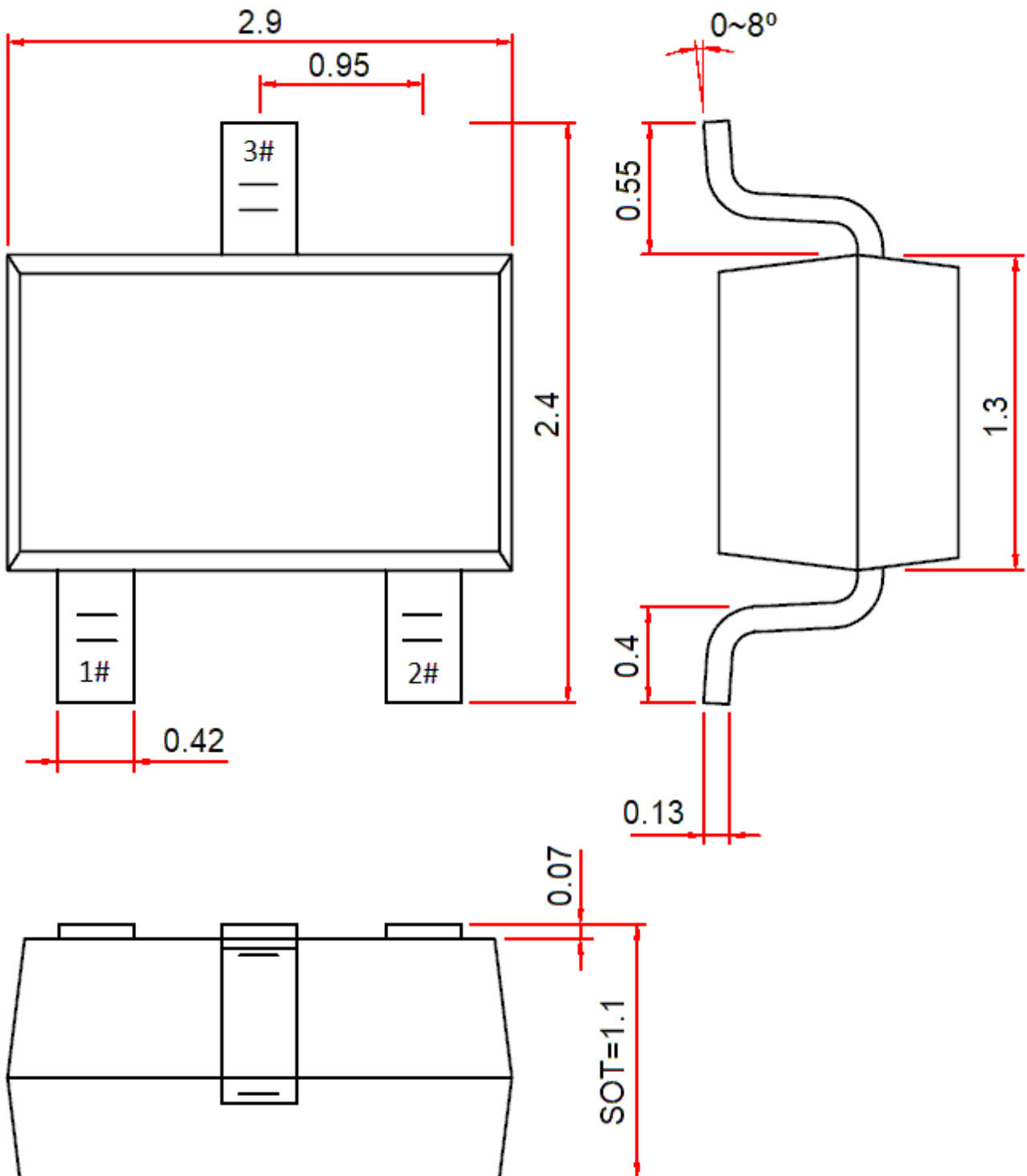

SOT23-5、TSOT23-5L

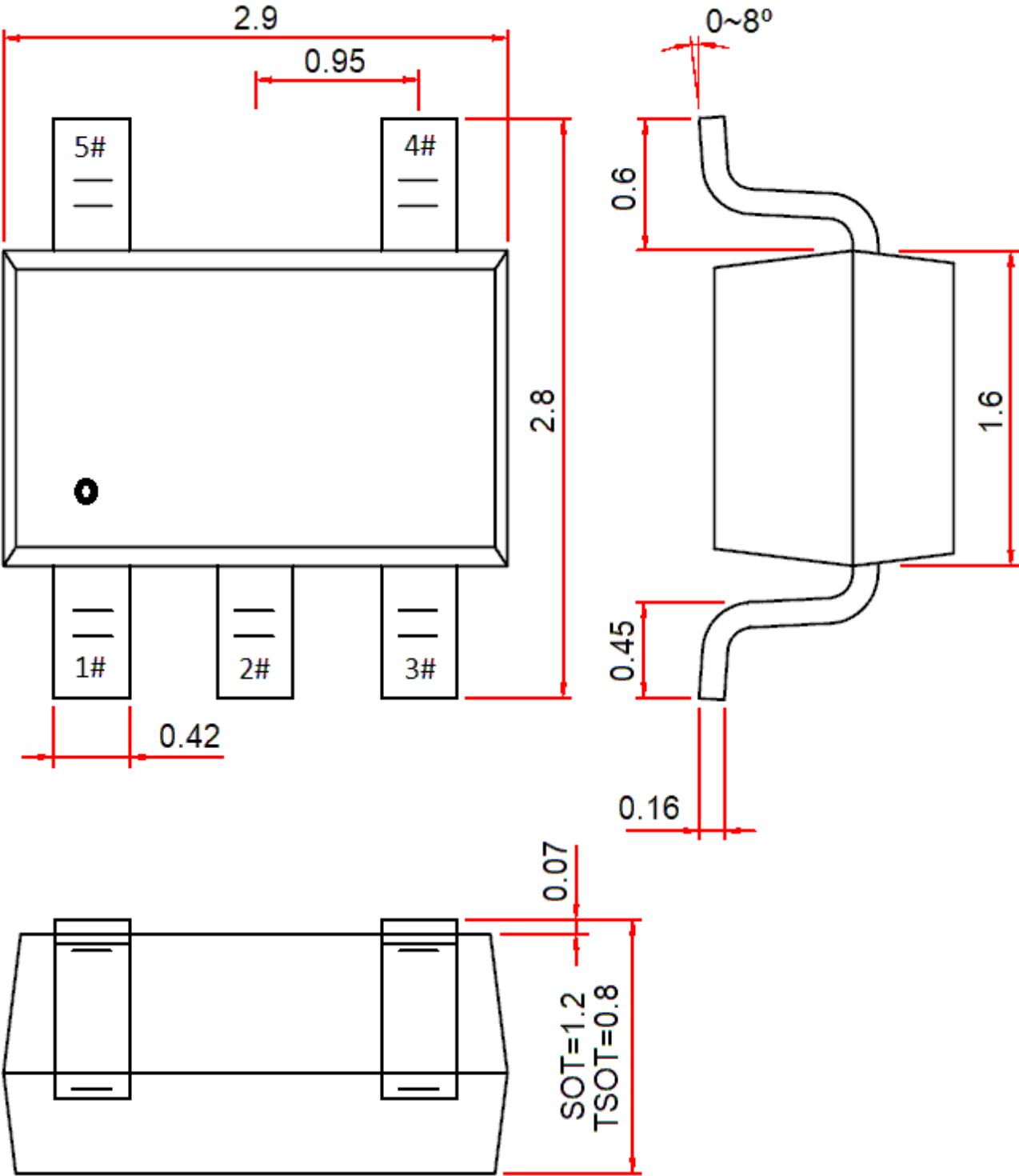

SOT23-6、TSOT23-6L

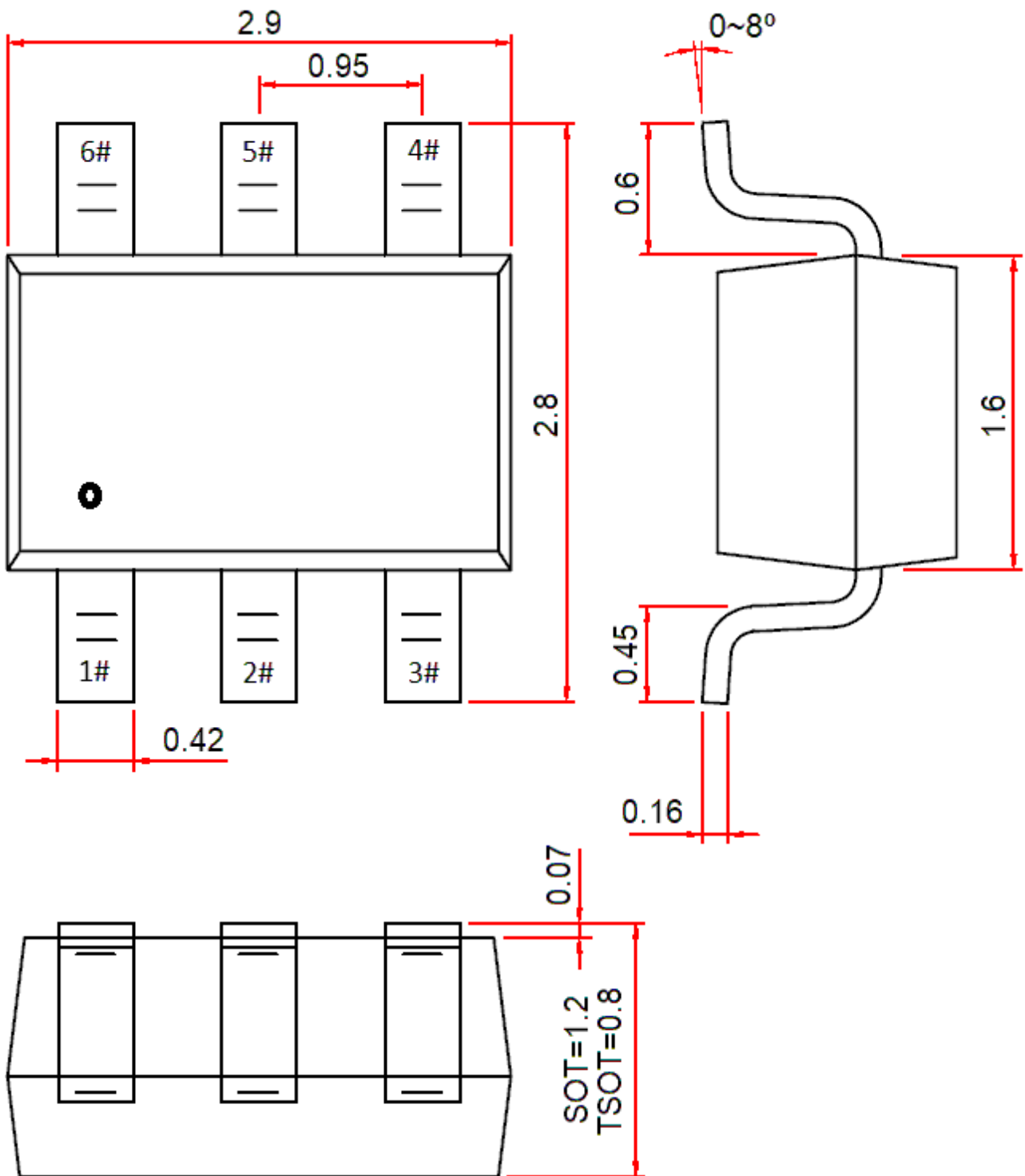

SOT23-8、TSOT23-8L

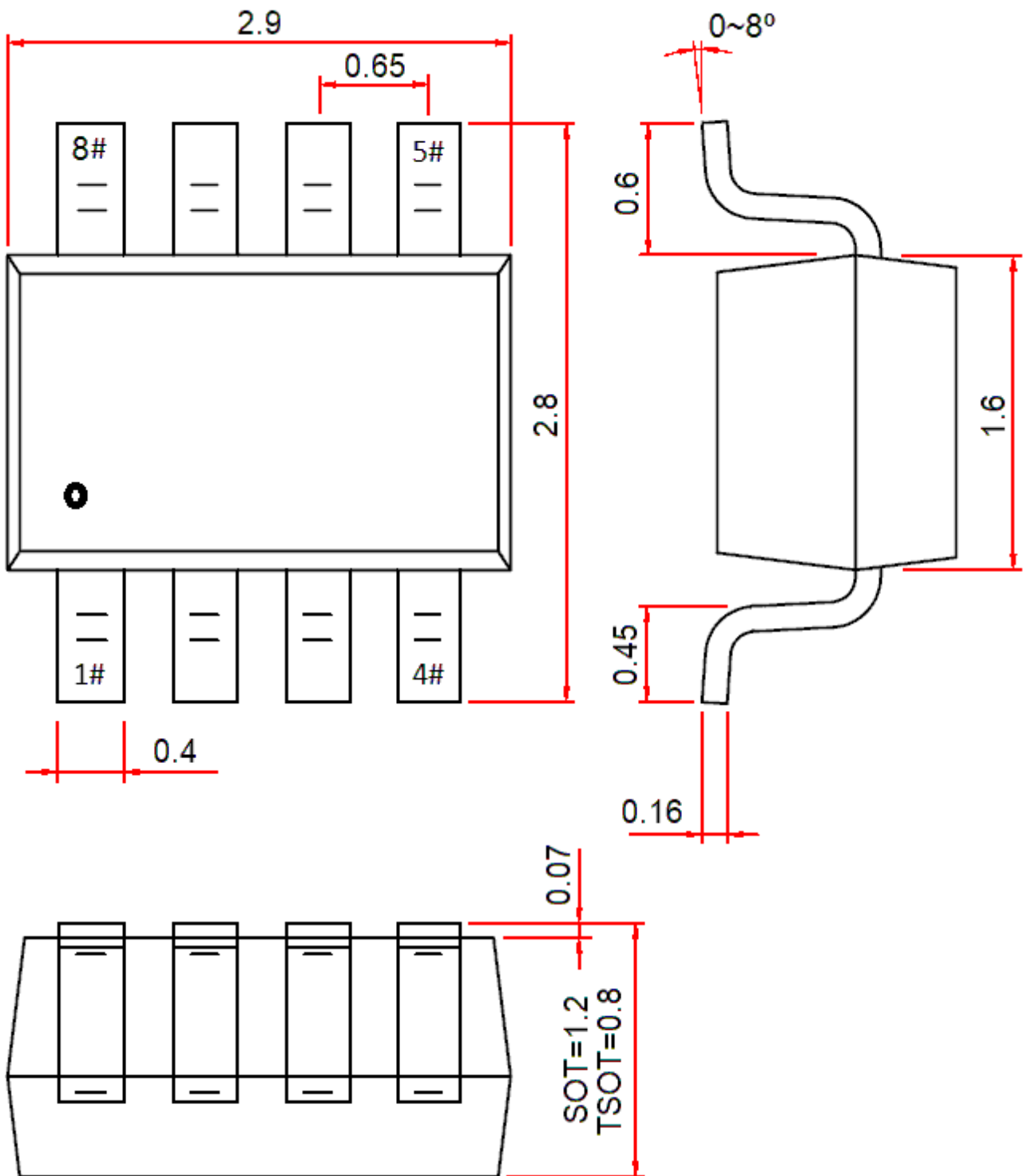

SOT363 (SC70-6L)

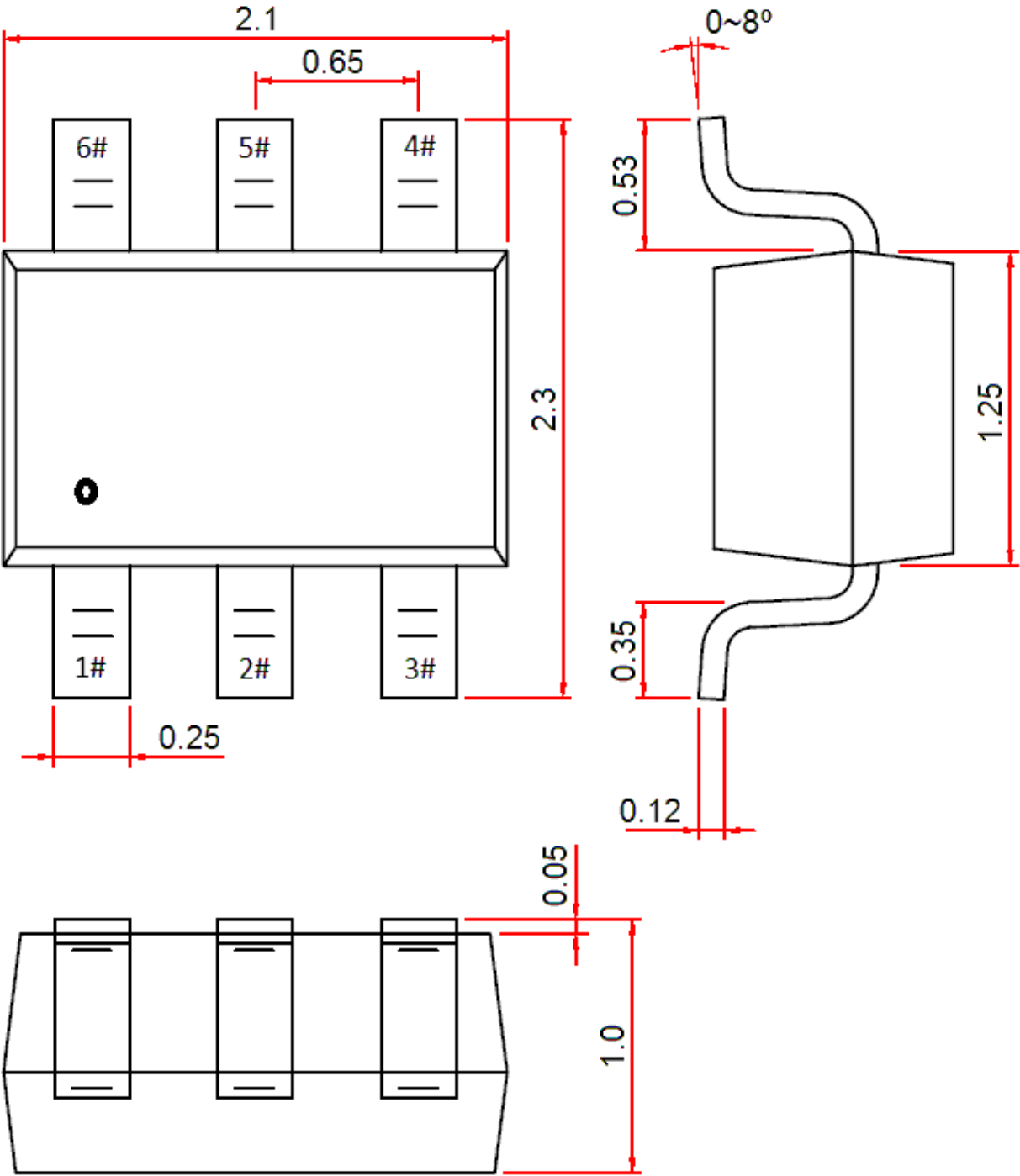

SOT353 (SC70-5L)

