

### ZH1.5 1x10P

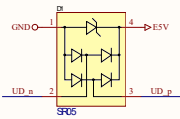

SSRX_n	1	IO 1	NC	10	SSRX_n
SSRX_p	2	IO 2	NC	9	SSRX_p
GND	3	GND	NC	8	GND
SS7X_n	4	IO 3	NC	7	SS7X_n
SS7X_p	5	IO 4	NC	6	SS7X_p

SPI004U-LG-04UG

Differential impedance of the USB interface(USB 2.0&3.0):100Ω

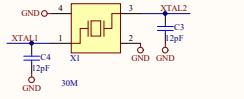
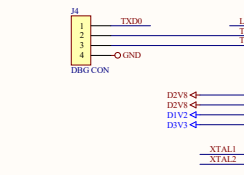

Differential impedance of the USB interface(USB 2.0&3.0):100Ω

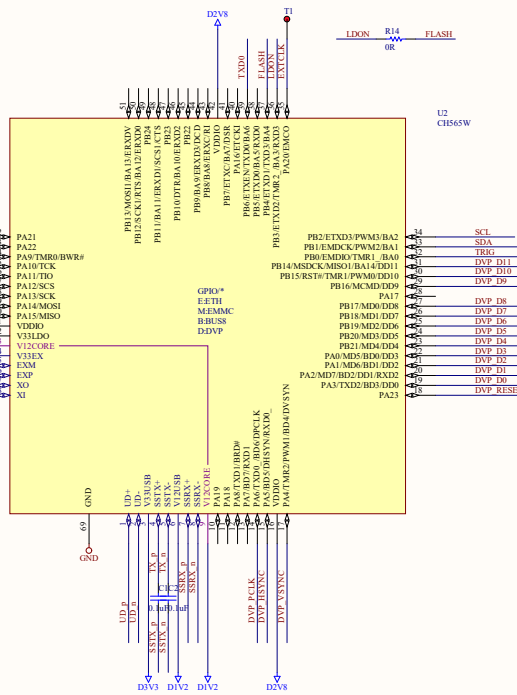

### CH565W

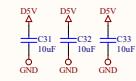
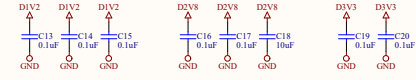

### POWER

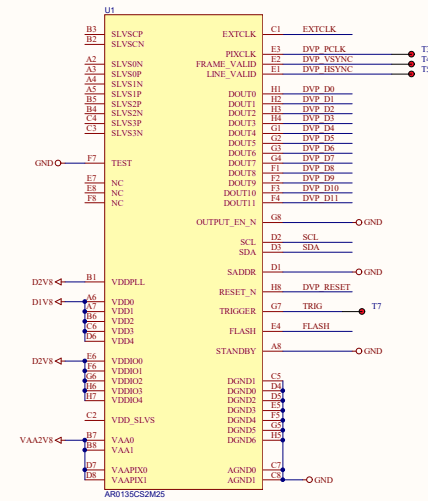

### AR0135CS2M25

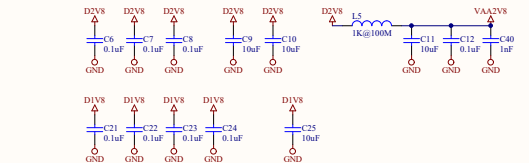

IC ADDR: 6x20

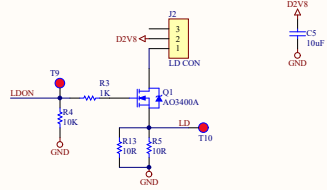

### LASER

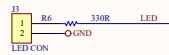

### LED

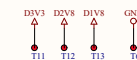
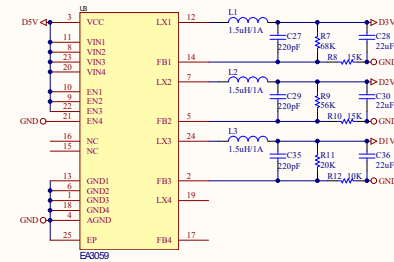

Title		
Size	Number	Revision
A2		
Date:	2023/4/26	Sheet of
File:	E-03_Kellm_USB0135_SchDoc	Drawn By: